

---

# CHROME

---

## Katalog dílů

Platnost od 07/2015

**RAVAK**<sup>®</sup>

# CSKK4 - 80, 90



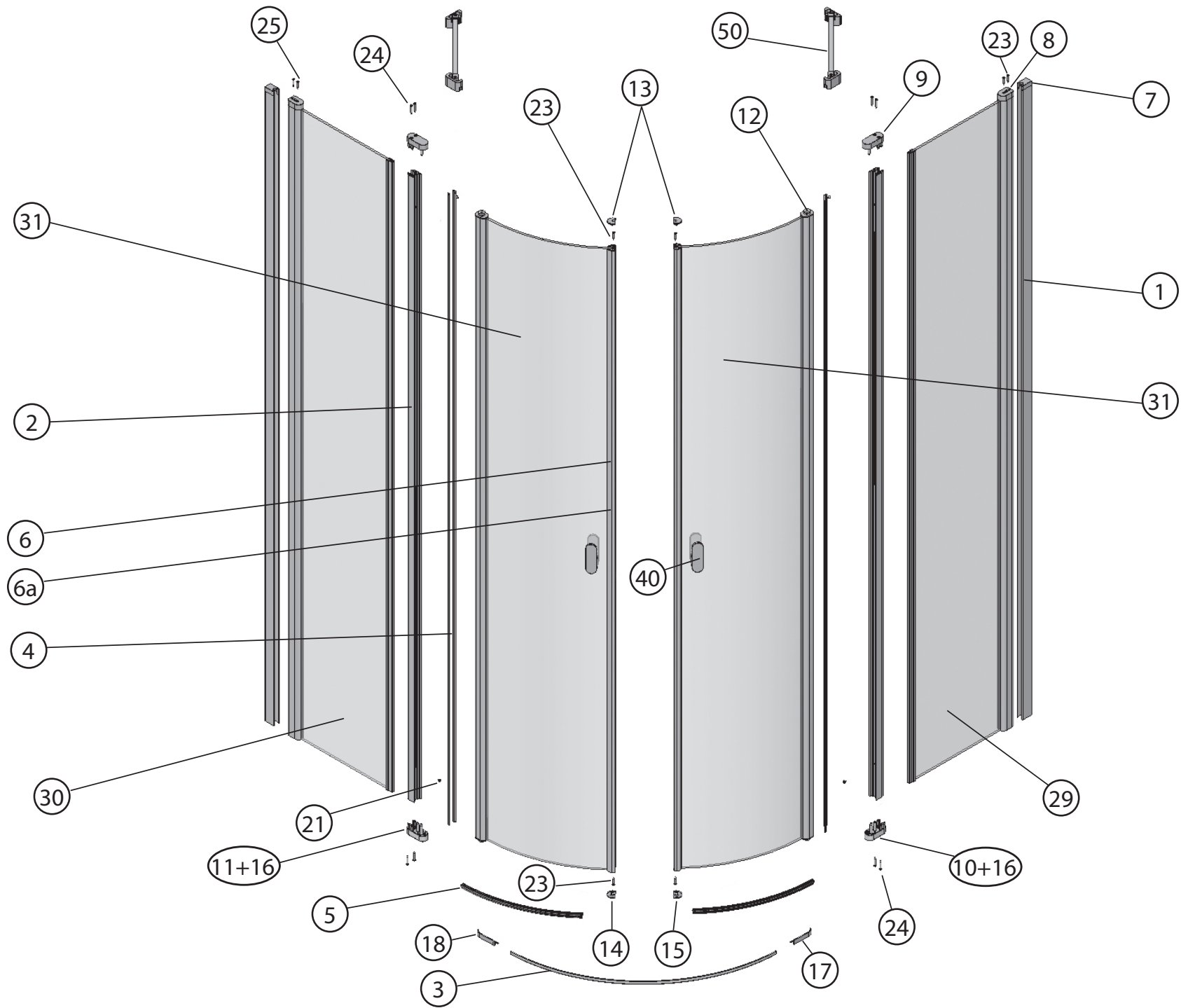



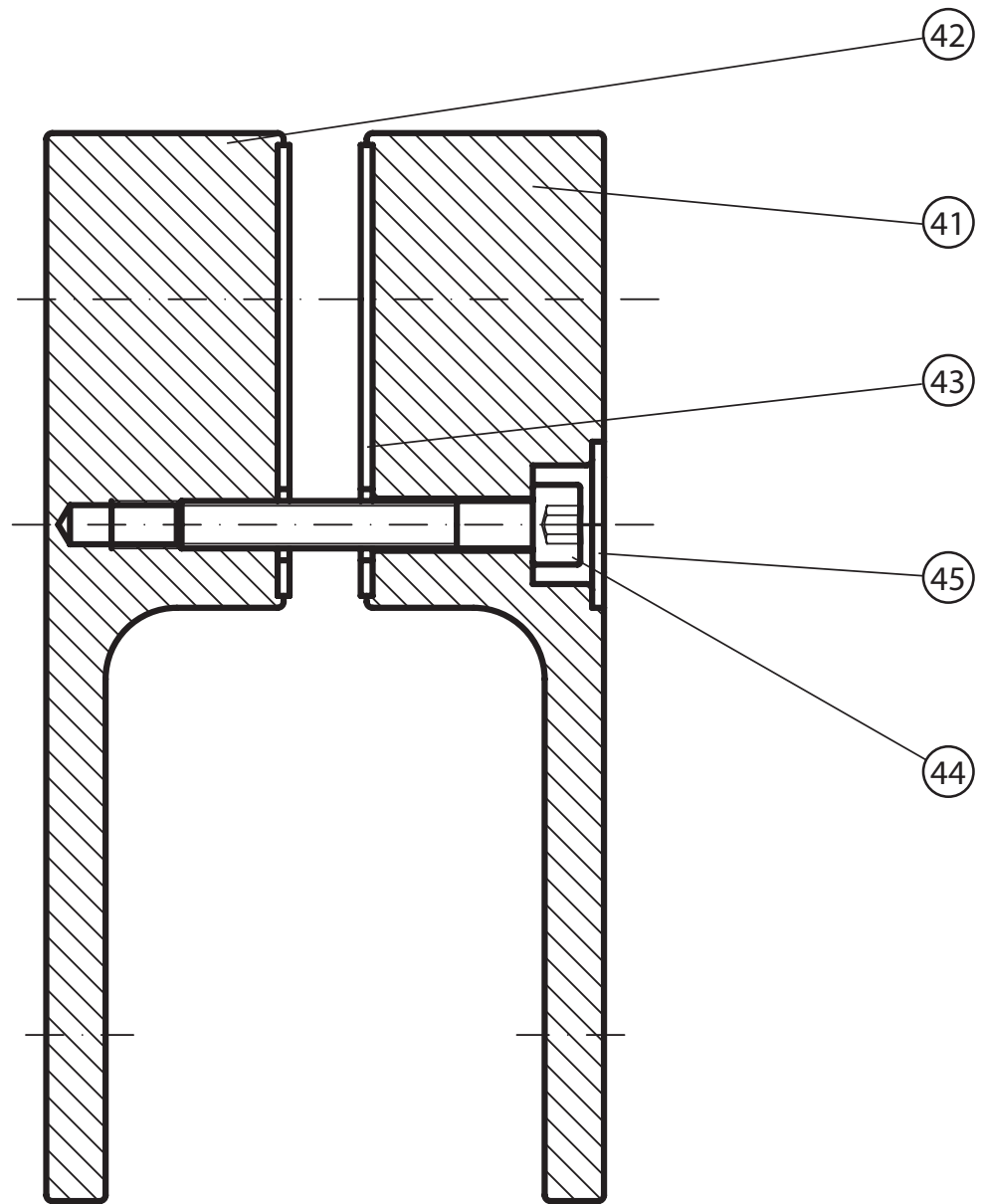



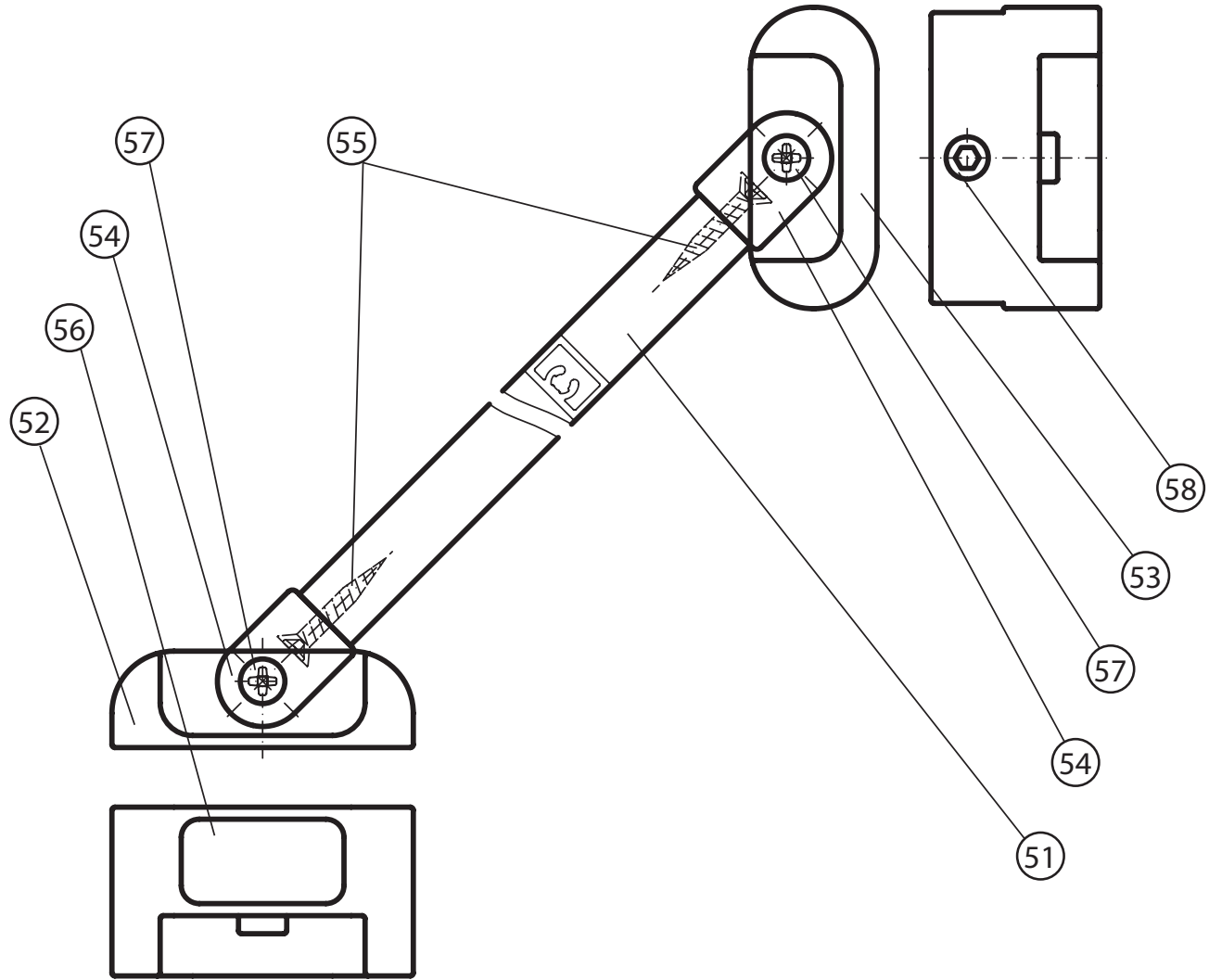































40















50



| <b>CSKK4 - 80, 90</b> |   |                       |                     |                     |                  |                  |                    |   |
|-----------------------|---|-----------------------|---------------------|---------------------|------------------|------------------|--------------------|---|
|                       | <b>Název:</b>                                       | <b>Množství [ks]:</b> | <b>Rozměr [mm]:</b> | <b>Pro výrobek:</b> | <b>SIČ bílá:</b> | <b>SIČ elox:</b> | <b>SIČ bright:</b> | <b>Obrázek:</b>   |
| 1                     | Ustavovací profil Chrome zesílený LR14698/01 1934   | 2                     | 1934                | CSKK4-80/90         | XVE6980111934    | XVE69801X1934    | XVE69801U1934      |    |
| 2                     | Svislý profil dveří/PS CHROME LR12244B              | 2                     | 1918                | CSKK4-80/90         | XVC2470111918    | XVC24701X1918    | XVC24701U1918      |    |
| 3                     | Prahová lišta                                       | 1                     | 1245                | CSKK4-80/90         | XVC40801U0735    |                  |                    |    |
| 4                     | Svislý těsnící profil CHROME dl.1938 mm             | 4                     | 1938                | CSKK4-80/90         | X8CRPL0301938    |                  |                    |    |
| 5                     | Vodorovná ostřížková lišta ohnutá CHROME dl.335 mm  | 2                     | 335                 | CSKK4-80/90         | X8CRPL0310335    |                  |                    |    |
| 6                     | Magnet ILPEA C0921 dl.1909 mm                       | 2                     | 1909                | CSKK4-80/90         | X6C092101909     |                  |                    |    |
| 6a                    | Svislý magnetový profil CSKK4 LR15437/01 white 1909 | 2                     | 1909                | CSKK4-80/90         | XVF4370111909    | XVF43701X1909    | XVF4370111909      |   |
| 7                     | Krycí plast ust. profilu CR-PL-001                  | 2                     |                     | CSKK4-80/90         | X8CRPL001000A    |                  |                    |    |
| 8                     | Krycí plast profilu CR-PL-002                       | 2                     |                     | CSKK4-80/90         | X8CRPL002000A    |                  |                    |    |
| 9                     | Hlavní plast horní 4D CR-PL-005-010                 | 2                     |                     | CSKK4-80/90         | X8CRZA015010A    |                  |                    |    |
| 10                    | Hlavní plast spodní 4D levý CR-PL-005-02L           | 1                     |                     | CSKK4-80/90         | X8CRPL00502LA    |                  |                    |    |
| 11                    | Hlavní plast spodní 4D pravý CR-PL-005-02P          | 1                     |                     | CSKK4-80/90         | X8CRPL00502PA    |                  |                    |    |
| 12                    | Krycí plast profilu CR-PL-007 / čep                 | 4                     |                     | CSKK4-80/90         | X8CRPL0070001    |                  |                    |    |
| 13                    | Krycí plast profilu horní CR-PL-008-010             | 2                     |                     | CSKK4-80/90         | X8CRPL008010A    |                  |                    |  |
| 14                    | Krycí plast profilu spodní levý CR-PL-008-02L       | 1                     |                     | CSKK4-80/90         | X8CRPL00802LO    |                  |                    |  |
| 15                    | Krycí plast profilu spodní pravý CR-PL-008-02P      | 1                     |                     | CSKK4-80/90         | X8CRPL00802PO    |                  |                    |  |
| 16                    | Zdvihací vložka stavitelná CR-PL-013                | 2                     |                     | CSKK4-80/90         | X8CRPL0130001    |                  |                    |  |
| 17                    | Koncovka prahové lišty D4 levá CR-PL-052-01L        | 1                     |                     | CSKK4-80/90         | X8CRPL05201LA    |                  |                    |  |
| 18                    | Koncovka prahové lišty D4 pravá CR-PL-052-01P       | 1                     |                     | CSKK4-80/90         | X8CRPL05201PA    |                  |                    |  |
| 19                    | Podložka krytky - Transparent                       | 4                     |                     | CSKK4-80/90         | X8A600000000     | X8A600000000     | X8BLPL157000       |  |
| 20                    | Krytka šroubu                                       | 4                     |                     | CSKK4-80/90         | X8A500000001     | X8A500000000     | X8BLPL15600A       |  |

|    |  |   |          |             |              |              |              |   |
|----|--|---|----------|-------------|--------------|--------------|--------------|---|
| 21 | Šroub samořezný 3,5x9,5 DIN 7981 A2 nerez  | 6 | ø3,5x9,5 | CSKK4-80/90 | X97981035095 |              |              |    |
| 22 | Šroub samořezný 3,5x13 DIN 7981 A2 nerez   | 4 | ø3,5x13  | CSKK4-80/90 | X97981035130 |              |              |    |
| 23 | Šroub samořezný 3,5x13 DIN 7982 nerez      | 6 | ø3,5x13  | CSKK4-80/90 | X97982035130 |              |              |    |
| 24 | Šroub samořezný 3,5 x 32 DIN 7981 A2 nerez | 8 | ø3,5x32  | CSKK4-80/90 | X97981035320 |              |              |    |
| 25 | Šroub samořezný 3,5 x 32 DIN 7982 A2 nerez | 2 | ø3,5x32  | CSKK4-80/90 | X97982035320 |              |              |    |
| 27 | Hmoždinka Ø 8                              | 6 | ø8x40    | CSKK4-80/90 | X20600080000 | X20600080000 | X20600080000 |    |
| 28 | Vrut do hmoždinky 4x40                     | 6 | ø4x40    | CSKK4-80/90 | X94000040400 | X94000040400 | X94000040400 |    |
| 29 | Pevná stěna pravá - CSKK4 80               | 1 |          | CSKK4-80    | XNDCRPS12250 | XNDCRPSX2250 | XNDCRPSU2250 |    |
| 29 | Pevná stěna pravá - CSKK4 90               | 1 |          | CSKK4-90    | XNDCRPS13250 | XNDCRPSX3250 | XNDCRPSU3250 |    |
| 30 | Pevná stěna levá - CSKK4 80                | 1 |          | CSKK4-80    | XNDCRPS12250 | XNDCRPSX2250 | XNDCRPSU2250 |    |
| 30 | Pevná stěna levá - CSKK4 90                | 1 |          | CSKK4-90    | XNDCRPS13250 | XNDCRPSX3250 | XNDCRPSU3250 |    |
| 31 | Dveře CSKK4                                | 2 |          | CSKK4-80/90 | XNDCRDV13610 | XNDCRDVX3610 | XNDCRDVU3610 |    |
| 40 | Madlo Chrome 3 komplet vč. Obalu           | 2 | set      | CSKK4-80/90 | X3CRMAD3000A | X3CRMAD3000A | X3CRMAD3000A |   |
| 41 | Madlo CHROME 1 vnitřní                     | 1 | 90x20x28 |             | ↑set↑        | ↑set↑        | ↑set↑        |  |
| 42 | Madlo CHROME 1 vnější                      | 1 | 90x20x28 |             | ↑set↑        | ↑set↑        | ↑set↑        |  |
| 43 | Podložka madla CHROME 1                    | 2 |          |             | ↑set↑        | ↑set↑        | ↑set↑        |  |
| 44 | Šroub M4x30 DIN 912 A2 nerez               | 1 | M4x30    |             | ↑set↑        | ↑set↑        | ↑set↑        |  |
| 45 | Krytka nerez pro madlo CHROME 1            | 1 | 24x14    |             | ↑set↑        | ↑set↑        | ↑set↑        |  |
| 40 | Sada madlo CHROME 3                        | 2 | set      | CSKK4-80/90 | X            | X            | X            |   |
| 41 | Madlo CHROME 3 vnitřní                     | 1 | 95x30x29 |             | ↑set↑        | ↑set↑        | ↑set↑        |  |

|    |                                       |   |          |             |               |               |               |   |
|----|---------------------------------------|---|----------|-------------|---------------|---------------|---------------|---|
| 42 | Madlo CHROME 3 vnější                 | 1 | 95x30x29 |             | ↑set↑         | ↑set↑         | ↑set↑         |  |
| 43 | Podložka madla CHROME 3               | 2 |          |             | ↑set↑         | ↑set↑         | ↑set↑         |  |
| 44 | Šroub M4x30 DIN 912 A2 nerez          | 1 | M4x40    |             | ↑set↑         | ↑set↑         | ↑set↑         |  |
| 45 | Krytka nerez pro madlo CHROME 1       | 1 | 24x14    |             | ↑set↑         | ↑set↑         | ↑set↑         |  |
|    |                                       |   |          |             |               |               |               |   |
| 50 | Vzpěra krátká Chrome                  | 2 | set      | CSKK4-80/90 | X3CRVZ249000A | X3CRVZ249000A | X3CRVZ249000A |  |
| 51 | Tyčka vřpěry krátká                   | 1 |          |             | ↑set↑         | ↑set↑         | ↑set↑         |  |
| 52 | Úchyt vřpěry - zed'                   | 1 |          |             | ↑set↑         | ↑set↑         | ↑set↑         |  |
| 53 | Úchyt vřpěry - sklo                   | 1 |          |             | ↑set↑         | ↑set↑         | ↑set↑         |  |
| 54 | Koncovka tyčky vřpěry                 | 2 |          |             | ↑set↑         | ↑set↑         | ↑set↑         |  |
| 55 | Šroub samořezný 3,5x20 DIN 7982 nerez | 2 | ø3,5x20  |             | ↑set↑         | ↑set↑         | ↑set↑         |  |
| 56 | Krytka nerez pro vřpěru               | 1 | 26x14    |             | ↑set↑         | ↑set↑         | ↑set↑         |  |
| 57 | Šroub M4x12 DIN965 nerez A2           | 2 | ø4x12    |             | ↑set↑         | ↑set↑         | ↑set↑         |  |
| 58 | Stavěcí šroub M8x8 DIN 913 nerez A2   | 1 | ø8x8     |             | ↑set↑         | ↑set↑         | ↑set↑         |  |



# CRV2 - 80, 90, 100, 110, 120



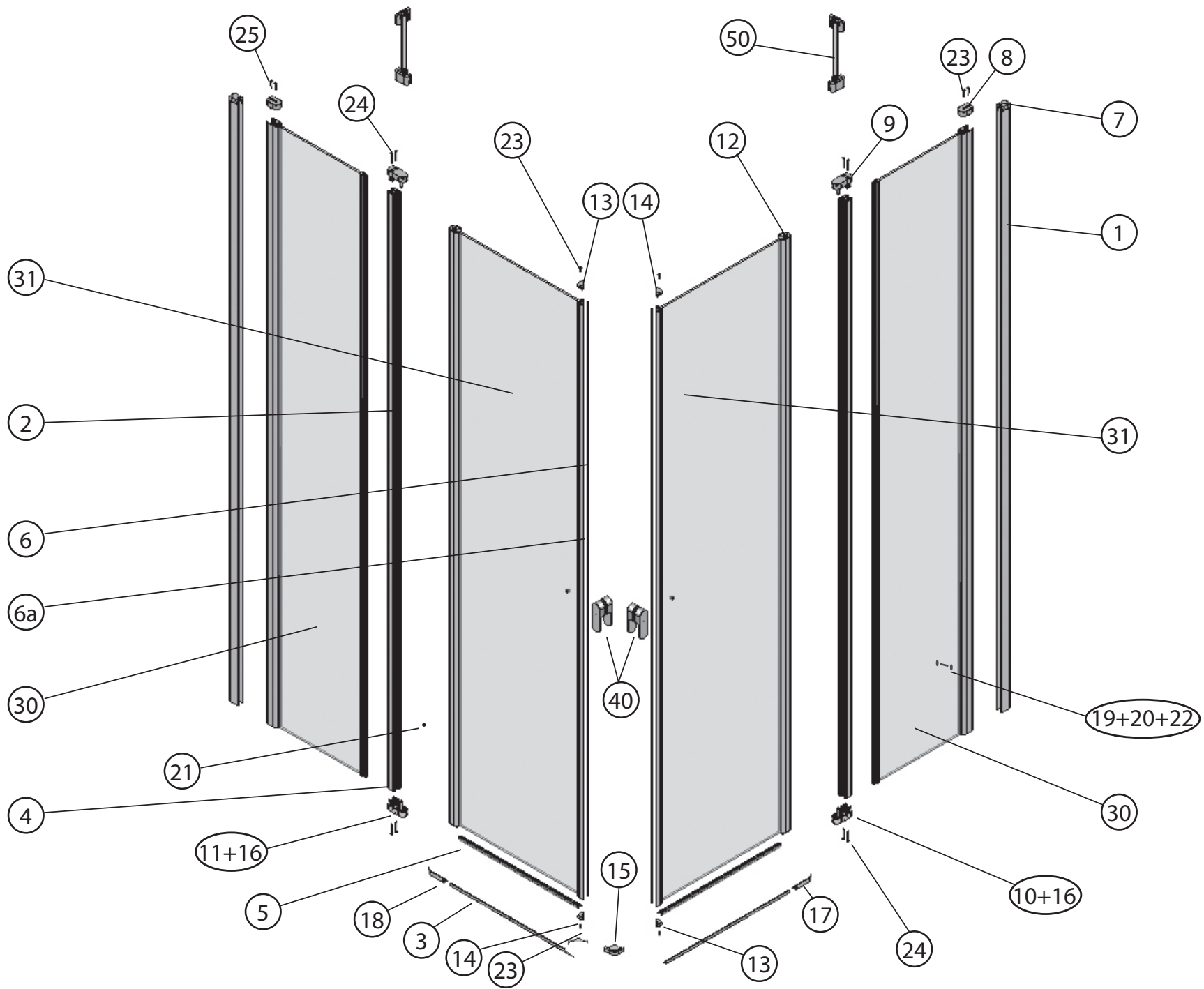



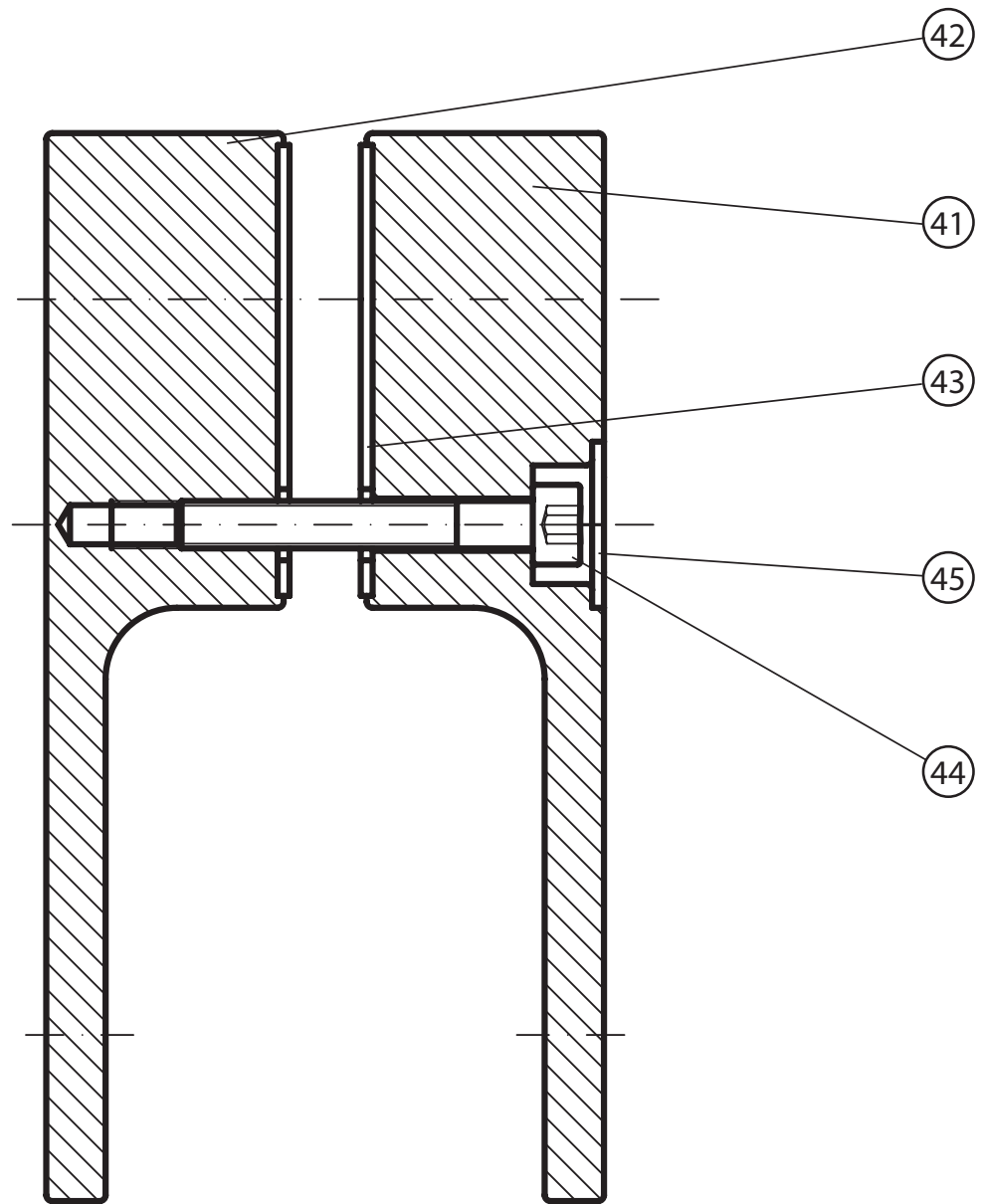



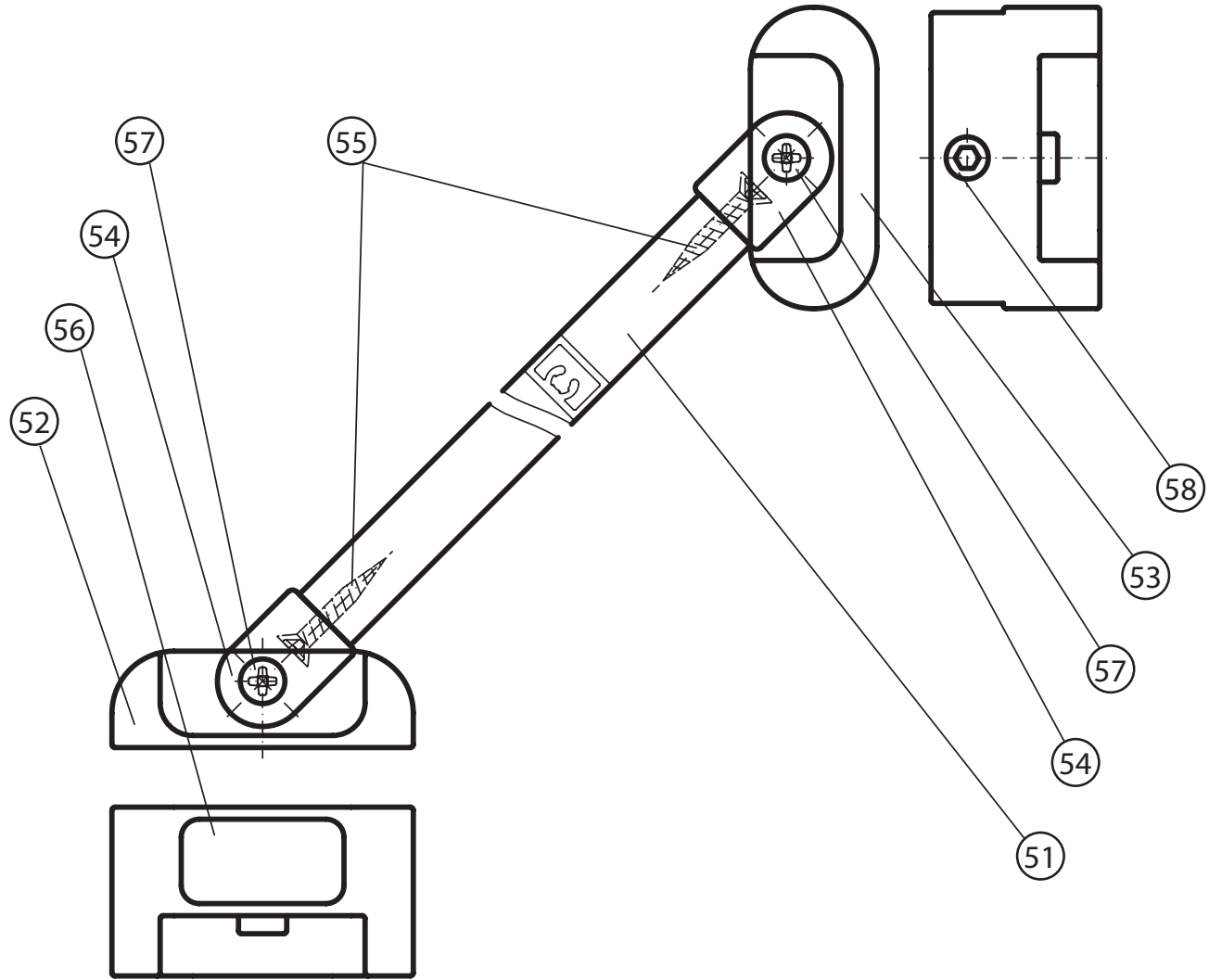



















40





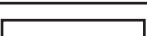
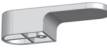



















50



| <b>CRV2 - 80, 90, 100, 110, 120</b> |  |                |              |                        |                 |               |               |   |
|-------------------------------------|--|----------------|--------------|------------------------|-----------------|---------------|---------------|---|
|                                     | Název:   | Množství [ks]: | Rozměr [mm]: | Pro výrobek:           | SIČ bílá:       | SIČ elox:     | SIČ bright:   | Obrázek:  |
| 1                                   | Ustavovací profil Chrome zesílený LR14698/01 1934  | 1              | 1934         | CRV2-80/90/100/110/120 | XVE6980111934   | XVE69801X1934 | XVE69801U1934 |    |
| 2                                   | Svislý profil dveří/PS CHROME LR12244B             | 1              | 1918         | CRV2-80/90/100/110/120 | XVC2470111918   | XVC24701X1918 | XVC24701U1918 |    |
| 3                                   | Prahová lišta CRV2-80/90/100                       | 1              | 457          | CRV2-80/90/100         | XVC40802U0457   |               |               |    |
| 3                                   | Prahová lišta CRV2-110/120                         | 1              | 557          | CRV2-110/120           | XVC40802U0557   |               |               |    |
| 4                                   | Svislý těsnící profil CHROME dl.1938 mm            | 2              | 1938         | CRV2-80/90/100/110/120 | X8CRPL0301938   |               |               |    |
| 5                                   | Vodorovná ostřížková lišta ohnutá CHROME dl.440 mm | 1              | 440          | CRV2-80/90/100         | X8CRPL0310440   |               |               |    |
| 5                                   | Vodorovná ostřížková lišta CHROME/Pivot dl.540 mm  | 1              | 540          | CRV2-110/120           | X8CRPL656715540 |               |               |    |
| 6                                   | Magnet ILPEA C0921 dl.1909 mm                      | 1              | 1909         | CRV2-80/90/100/110/120 | X6C092101909    |               |               |    |
| 6a                                  | Svislý magnetový profil 45 Chrome LR12245/1 1909   | 1              | 1909         | CRV2-80/90/100/110/120 | XVF4260111909   | XVF42601X1909 | XVF42601U1909 |    |
| 7                                   | Krycí plast ust. profilu CR-PL-001                 | 1              |              | CRV2-80/90/100/110/120 | X8CRPL001000A   |               |               |    |
| 8                                   | Krycí plast profilu CR-AL-002 - CR-PL-002          | 1              |              | CRV2-80/90/100/110/120 | X8CRPL002000A   |               |               |    |
| 9                                   | Hlavní plast horní 4D CR-PL-005-010                | 1              |              | CRV2-80/90/100/110/120 | X8CRZA015010A   |               |               |    |
| 10                                  | Hlavní plast spodní 4D levý CR-PL-005-02L          | 1              |              | CRV2-80/90/100/110/120 | X8CRPL00502LA   |               |               |   |
| 11                                  | Hlavní plast spodní 4D pravý CR-PL-005-02P         | 1              |              | CRV2-80/90/100/110/120 | X8CRPL00502PA   |               |               |  |
| 12                                  | Krycí plast profilu CR-PL-007 / čep                | 2              |              | CRV2-80/90/100/110/120 | X8CRPL0070001   |               |               |  |
| 13                                  | Krycí plast profilu pravý CR-PL-009-01P            | 1              |              | CRV2-80/90/100/110/120 | X8CRPL00901PA   |               |               |  |
| 14                                  | Krycí plast profilu levý CR-PL-009-01L             | 1              |              | CRV2-80/90/100/110/120 | X8CRPL00901LA   |               |               |  |
| 15                                  | Rohová spojka prahové lišty CR-PL-051              | 1              |              | CRV2-80/90/100/110/120 | X8CRPL051000A   |               |               |  |
| 16                                  | Zdvíhací vložka stavitelná CR-PL-013               | 1              |              | CRV2-80/90/100/110/120 | X8CRPL0130001   |               |               |  |
| 17                                  | Koncovka prahové lišty D4 levá CR-PL-052-01L       | 1              |              | CRV2-80/90/100/110/120 | X8CRPL05201LA   |               |               |  |
| 18                                  | Koncovka prahové lišty D4 pravá CR-PL-052-01P      | 1              |              | CRV2-80/90/100/110/120 | X8CRPL05201PA   |               |               |  |

|    |  |   |          |                        |              |              |              |   |
|----|--|---|----------|------------------------|--------------|--------------|--------------|---|
| 19 | Podložka krytky - Transparent            | 2 |          | CRV2-80/90/100/110/120 | X8A600000000 | X8A600000000 | X8BLPL157000 |    |
| 20 | Krytka šroubu                            | 2 |          | CRV2-80/90/100/110/120 | X8A500000001 | X8A500000000 | X8BLPL15600A |    |
| 21 | Šroub samořez 3,5x9,5 DIN 7981 A2 nerez  | 3 | ø3,5x9,5 | CRV2-80/90/100/110/120 |              | X97981035095 |              |    |
| 22 | Šroub samořezný 3,5x13 DIN 7981 A2 nerez | 2 | ø3,5x13  | CRV2-80/90/100/110/120 |              | X97981035130 |              |    |
| 23 | Šroub samořez 3,5x13 DIN 7982 nerez      | 3 | ø3,5x13  | CRV2-80/90/100/110/120 |              | X97982035130 |              |    |
| 24 | Šroub samořez 3,5 x 32 DIN 7981 A2 nerez | 4 | ø3,5x32  | CRV2-80/90/100/110/120 |              | X97981035320 |              |    |
| 25 | Šroub samořez 3,5 x 32 DIN 7982 A2 nerez | 1 | ø3,5x32  | CRV2-80/90/100/110/120 |              | X97982035320 |              |    |
| 27 | Hmoždinka Ø 8                            | 3 | ø8x40    | CRV2-80/90/100/110/120 | X20600080000 | X20600080000 | X20600080000 |    |
| 28 | Vrut do hmoždinky 4x40                   | 3 | ø4x40    | CRV2-80/90/100/110/120 | X94000040400 | X94000040400 | X94000040400 |    |
|    |  |   |          |                        |              |              |              |   |
| 30 | Pevná stěna - CRV2 80                    | 1 |          | CRV2-80                | XNDCRPS12250 | XNDCRPSX2250 | XNDCRPSU2250 |    |
| 30 | Pevná stěna - CRV2 90                    | 1 |          | CRV2-90                | XNDCRPS13250 | XNDCRPSX3250 | XNDCRPSU3250 |    |
| 30 | Pevná stěna - CRV2 100,110               | 1 |          | CRV2-100/120           | XNDCRPS14250 | XNDCRPSX4250 | XNDCRPSU4250 |    |
| 30 | Pevná stěna - CRV2 120                   | 1 |          | CRV2-120               | XNDCRPS15250 | XNDCRPSX5250 | XNDCRPSU5250 |    |
| 31 | Dveře CRV2 - 80,90,100                   | 1 |          | CRV2-80/90/100         | XNDCRDV14610 | XNDCRDVX4610 | XNDCRDVU4610 |    |
| 31 | Dveře CRV2 - 110, 120                    | 1 |          | CRV2-110/120           | XNDCRDV15610 | XNDCRDVX5610 | XNDCRDVU5610 |  |
|    |  |   |          |                        |              |              |              |   |
| 40 | Madlo Chrome 3 komplet vč. Obalu         | 1 | set      | CRV2-80/90/100/110/120 | X3CRMAD3000A | X3CRMAD3000A | X3CRMAD3000A |   |
| 41 | Madlo CHROME 1 vnitřní                   | 1 | 90x20x28 |                        | ↑set↑        | ↑set↑        | ↑set↑        |  |
| 42 | Madlo CHROME 1 vnější                    | 1 | 90x20x28 |                        | ↑set↑        | ↑set↑        | ↑set↑        |  |
| 43 | Podložka madla CHROME 1                  | 2 |          |                        | ↑set↑        | ↑set↑        | ↑set↑        |  |
| 44 | Šroub M4x30 DIN 912 A2 nerez             | 1 | M4x30    |                        | ↑set↑        | ↑set↑        | ↑set↑        |  |
| 45 | Krytka nerez pro madlo CHROME 1          | 1 | 24x14    |                        | ↑set↑        | ↑set↑        | ↑set↑        |  |

|    |                                     |   |          |                        |               |               |               |   |
|----|-------------------------------------|---|----------|------------------------|---------------|---------------|---------------|---|
| 40 | Sada madlo CHROME 3                 | 1 | set      | CRV2-80/90/100/110/120 | X3CRMAD3000A  | X3CRMAD3000A  | X3CRMAD3000A  |    |
| 41 | Madlo CHROME 3 vnitřní              | 1 | 95x30x29 |                        | ↑set↑         | ↑set↑         | ↑set↑         |    |
| 42 | Madlo CHROME 3 vnější               | 1 | 95x30x29 |                        | ↑set↑         | ↑set↑         | ↑set↑         |    |
| 43 | Podložka madla CHROME 3             | 2 |          |                        | ↑set↑         | ↑set↑         | ↑set↑         |    |
| 44 | Šroub M4x30 DIN 912 A2 nerez        | 1 | M4x40    |                        | ↑set↑         | ↑set↑         | ↑set↑         |    |
| 45 | Krytka nerez pro madlo CHROME 1     | 1 | 24x14    |                        | ↑set↑         | ↑set↑         | ↑set↑         |    |
|    |                                     |   |          |                        |               |               |               |   |
| 50 | Vzpěra krátká Chrome 80,90          | 1 | set      | CRV2-80/90             | X3CRVZ249000A | X3CRVZ249000A | X3CRVZ249000A |   |
| 51 | Tyčka vřpěry krátká                 | 1 | 249      |                        | ↑set↑         | ↑set↑         | ↑set↑         |    |
| 52 | Úchyt vřpěry - zed'                 | 1 |          |                        | ↑set↑         | ↑set↑         | ↑set↑         |    |
| 53 | Úchyt vřpěry - sklo                 | 1 |          |                        | ↑set↑         | ↑set↑         | ↑set↑         |    |
| 54 | Koncovka tyčky vřpěry               | 2 |          |                        | ↑set↑         | ↑set↑         | ↑set↑         |    |
| 55 | Šroub samořez 3,5x20 DIN 7982 nerez | 2 | ø3,5x20  |                        | ↑set↑         | ↑set↑         | ↑set↑         |    |
| 56 | Krytka nerez pro vřpěru             | 1 | 26x14    |                        | ↑set↑         | ↑set↑         | ↑set↑         |    |
| 57 | Šroub M4x12 DIN965 nerez A2         | 2 | ø4x12    |                        | ↑set↑         | ↑set↑         | ↑set↑         |   |
| 58 | Stavěcí šroub M8x8 DIN 913 nerez A2 | 1 | ø8x8     |                        | ↑set↑         | ↑set↑         | ↑set↑         |  |
|    |                                     |   |          |                        |               |               |               |   |
| 50 | Vzpěra dlouhá Chrome 100,110,120    | 2 | set      | CRV2-100/110/120       | X3CRVZ320000A | X3CRVZ320000A | X3CRVZ320000A |   |
| 51 | Tyčka vřpěry dlouhá                 | 1 | 320      |                        | ↑set↑         | ↑set↑         | ↑set↑         |  |
| 52 | Úchyt vřpěry - zed'                 | 1 |          |                        | ↑set↑         | ↑set↑         | ↑set↑         |  |
| 53 | Úchyt vřpěry - sklo                 | 1 |          |                        | ↑set↑         | ↑set↑         | ↑set↑         |  |
| 54 | Koncovka tyčky vřpěry               | 2 |          |                        | ↑set↑         | ↑set↑         | ↑set↑         |  |
| 55 | Šroub samořez 3,5x20 DIN 7982 nerez | 2 | ø3,5x20  |                        | ↑set↑         | ↑set↑         | ↑set↑         |  |

|    |                                     |   |       |  |       |       |       |   |
|----|-------------------------------------|---|-------|--|-------|-------|-------|---|
| 56 | Krytka nerez pro vzpěru             | 1 | 26x14 |  | ↑set↑ | ↑set↑ | ↑set↑ |  |
| 57 | Šroub M4x12 DIN965 nerez A2         | 2 | ø4x12 |  | ↑set↑ | ↑set↑ | ↑set↑ |  |
| 58 | Stavěcí šroub M8x8 DIN 913 nerez A2 | 1 | ø8x8  |  | ↑set↑ | ↑set↑ | ↑set↑ |  |



# CSD2 - 100, 110, 120

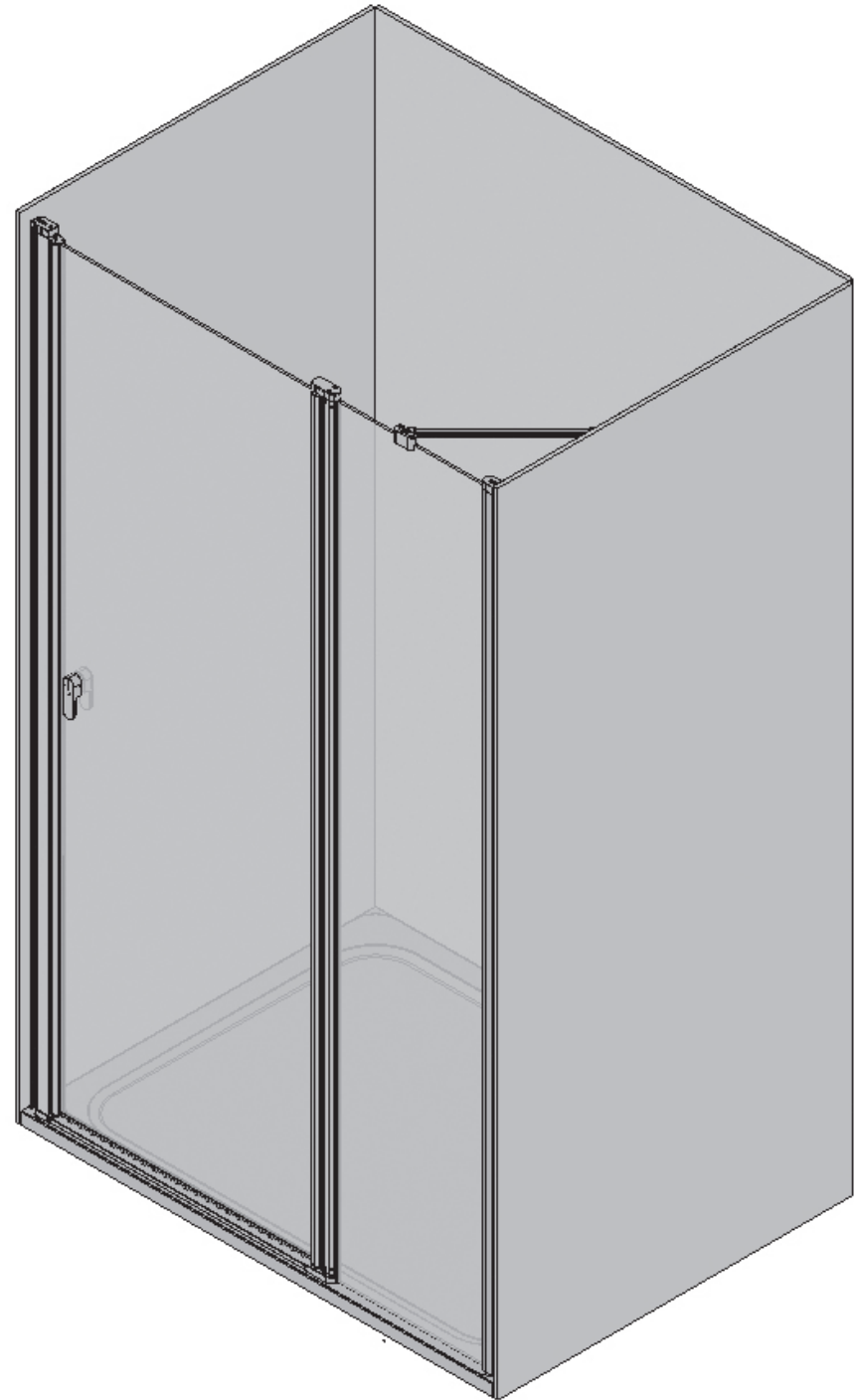

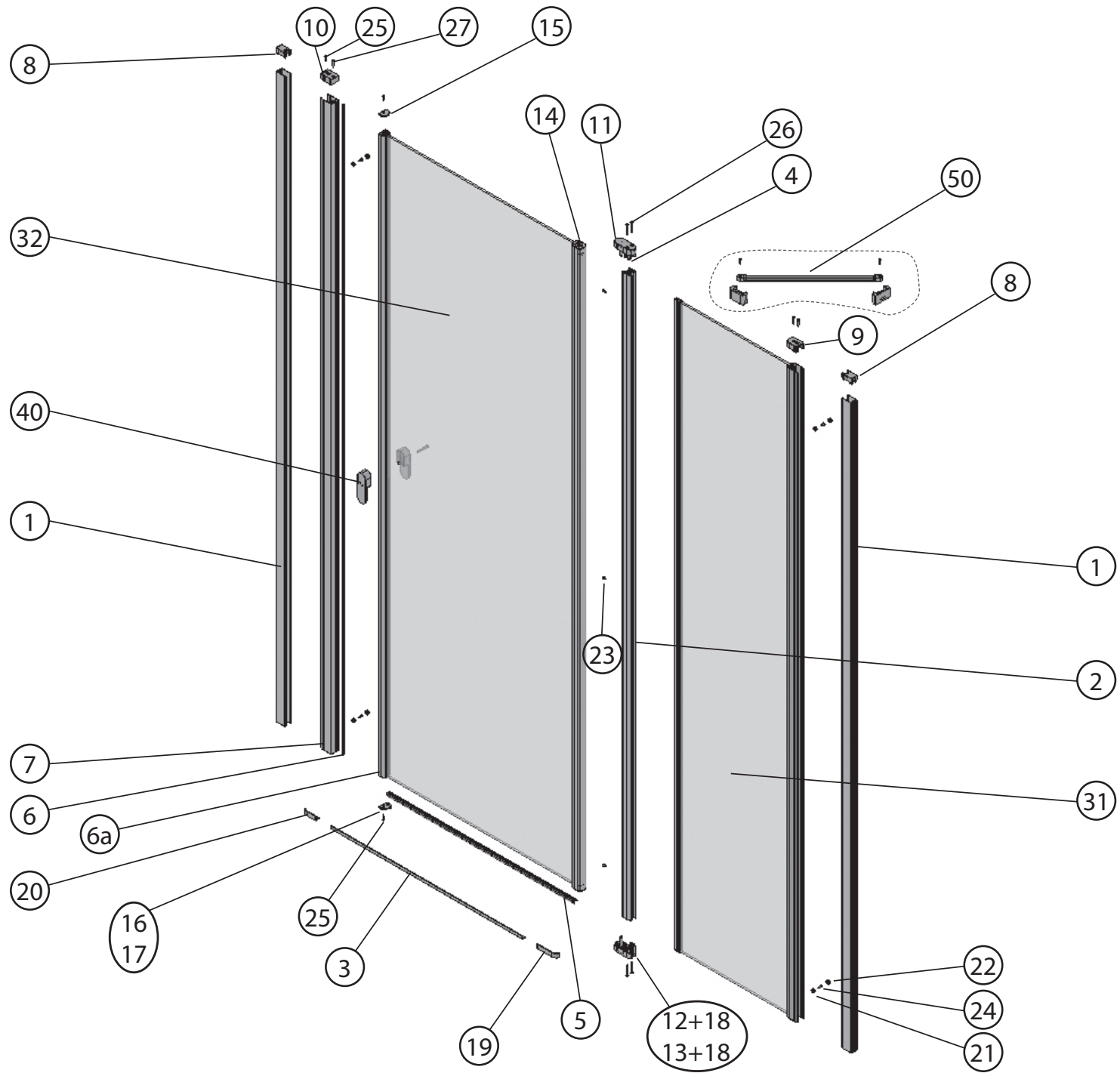



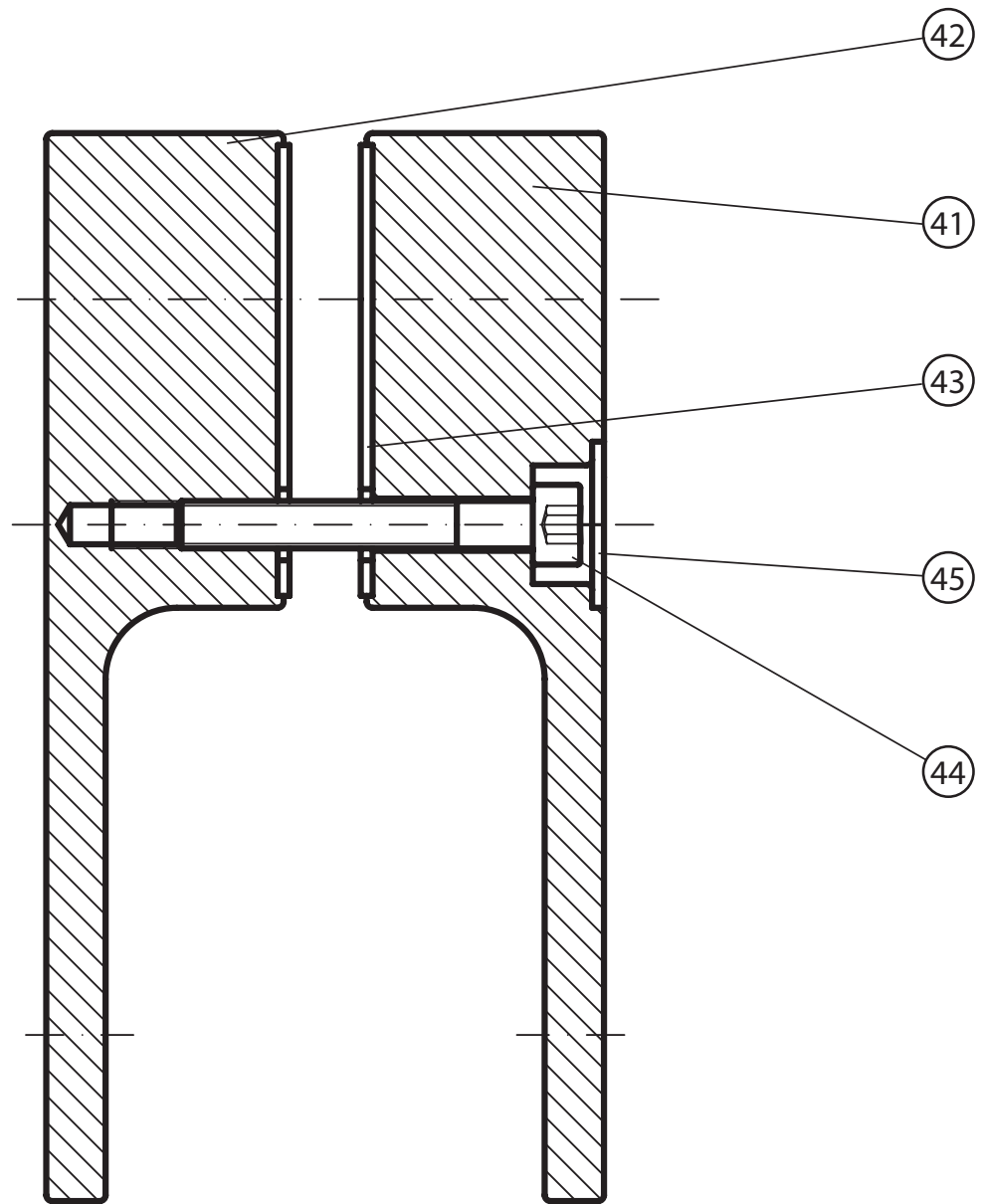



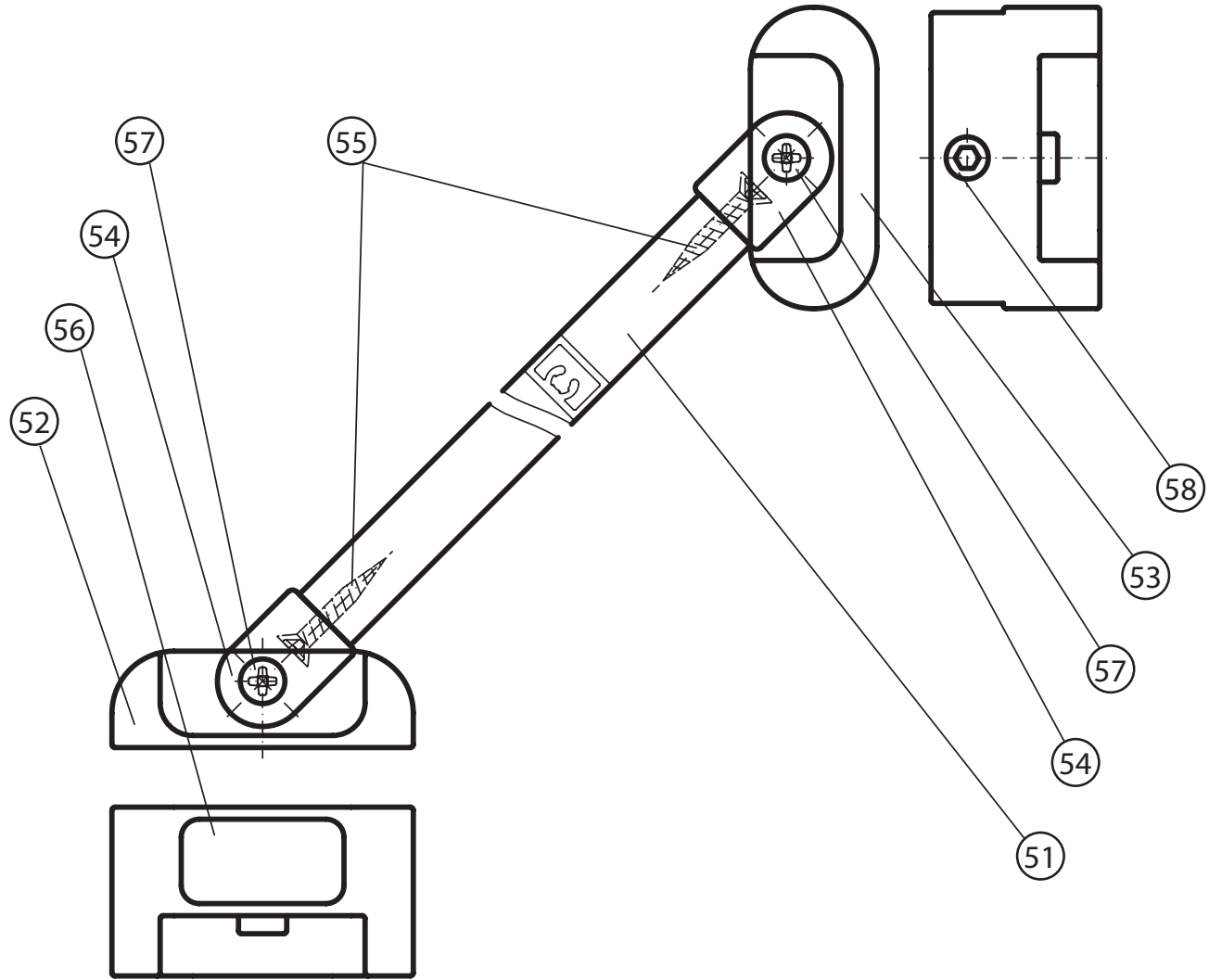















40

























50



| <b>CSD2 - 100,110,120</b> |   |                |              |                  |               |               |               |   |
|---------------------------|---|----------------|--------------|------------------|---------------|---------------|---------------|---|
|                           | Název:  | Množství [ks]: | Rožměr [mm]: | Pro výrobek:     | SIČ bílá:     | SIČ elox:     | SIČ bright:   | Obrázek:  |
| 1                         | Ustavovací profil Chrome zesílený LR14698/01 1934   | 2              | 1934         | CSD2-100/110/120 | XVE6980111934 | XVE69801X1934 | XVE69801U1934 |    |
| 2                         | Svislý profil dveří/PS CHROME LR12244B              | 1              | 1918         | CSD2-100/110/120 | XVC2470111918 | XVC24701X1918 | XVC24701U1918 |    |
| 3                         | Prahová lišta Chrome rovná Bright 555               | 1              | 555          | CSD2-100/110/120 | XVC40806U0555 |               |               |    |
| 4                         | Svislý těsnící profil CHROME dl.1938 mm             | 2              | 1938         | CSD2-100/110/120 | X8CRPL0301938 |               |               |    |
| 5                         | Vodorovná ostřiková lišta CHROME dl.637mm           | 1              | 637          | CSD2-100/110/120 | X8CRPL0310637 |               |               |    |
| 6                         | Magnet ILPEA C0921 dl.1909 mm                       | 2              | 1909         | CSD2-100/110/120 | X6C092101909  |               |               |    |
| 6a                        | Svislý magnetový profil přímý LR15427/01 white 1909 | 1              | 1909         | CSD2-100/110/120 | XVF4270111909 | XVF42701X1909 | XVF42701U1909 |   |
| 7                         | Svislý magnetový profil CHROME LR12248              | 1              | 1934         | CSD2-100/110/120 | XVC2480111934 | XVC24801X1934 | XVC24801U1934 |    |
| 8                         | Krycí plast ust. profilu CR-PL-001                  | 2              |              | CSD2-100/110/120 | X8CRPL001000A |               |               |    |
| 9                         | Krycí plast profilu CR-PL-002                       | 1              |              | CSD2-100/110/120 | X8CRPL002000A |               |               |    |
| 10                        | Krycí plast profilu CR-PL-003                       | 1              |              | CSD2-100/110/120 | X8CRPL003000A |               |               |    |
| 11                        | Hlavní plast horní 4D CR-PL-005-010                 | 1              |              | CSD2-100/110/120 | X8CRZA015010A |               |               |    |
| 12                        | Hlavní plast spodní 4D levý CR-PL-005-02L           | 1              |              | CSD2-100/110/120 | X8CRPL00502LA |               |               |   |
| 13                        | Hlavní plast spodní 4D pravý CR-PL-005-02P          | 1              |              | CSD2-100/110/120 | X8CRPL00502PA |               |               |  |
| 14                        | Krycí plast profilu CR-PL-007 / čep                 | 2              |              | CSD2-100/110/120 | X8CRPL0070001 |               |               |  |
| 15                        | Krycí plast profilu horní CR-PL-008-010             | 1              |              | CSD2-100/110/120 | X8CRPL008010A |               |               |  |
| 16                        | Krycí plast profilu spodní levý CR-PL-008-02L       | 1              |              | CSD2-100/110/120 | X8CRPL00802LO |               |               |  |
| 17                        | Krycí plast profilu spodní pravý CR-PL-008-02P      | 1              |              | CSD2-100/110/120 | X8CRPL00802PO |               |               |  |
| 18                        | Zdvíhací vložka stavitelná CR-PL-013                | 1              |              | CSD2-100/110/120 | X8CRPL0130001 |               |               |  |
| 19                        | Koncovka prahové lišty D4 levá CR-PL-052-01L        | 1              |              | CSD2-100/110/120 | X8CRPL05201LA |               |               |  |
| 19                        | Koncovka prahové lišty D4 pravá CR-PL-052-01P       | 1              |              | CSD2-100/110/120 | X8CRPL05201PA |               |               |  |

|    |   |   |          |                  |               |              |              |   |
|----|---|---|----------|------------------|---------------|--------------|--------------|---|
| 20 | Koncovka pr. lišty NIKA levá CR-PL-054-01L  | 1 |          | CSD2-100/110/120 | X8CRPL05401LA |              |              |    |
| 20 | Koncovka pr. lišty NIKA pravá CR-PL-054-01P | 1 |          | CSD2-100/110/120 | X8CRPL05401PA |              |              |    |
| 21 | Podložka krytky - Transparent               | 5 |          | CSD2-100/110/120 | X8A600000000  | X8A600000000 | X8BLPL157000 |    |
| 22 | Krytka šroubu                               | 5 |          | CSD2-100/110/120 | X8A500000001  | X8A500000000 | X8BLPL15600A |    |
| 23 | Šroub samořez 3,5x9,5 DIN 7981 A2 nerez     | 3 | ø3,5x9,5 | CSD2-100/110/120 | X97981035095  |              |              |    |
| 24 | Šroub samořezný 3,5x13 DIN 7981 A2 nerez    | 5 | ø3,5x13  | CSD2-100/110/120 | X97981035130  |              |              |    |
| 25 | Šroub samořez 3,5x13 DIN 7982 nerez         | 4 | ø3,5x13  | CSD2-100/110/120 | X97982035130  |              |              |    |
| 26 | Šroub samořez 3,5 x 32 DIN 7981 A2 nerez    | 4 | ø3,5x32  | CSD2-100/110/120 | X97981035320  |              |              |    |
| 27 | Šroub samořez 3,5 x 32 DIN 7982 A2 nerez    | 2 | ø3,5x32  | CSD2-100/110/120 | X97982035320  |              |              |    |
| 29 | Hmoždinka Ø 8                               | 6 | ø8x40    | CSD2-100/110/120 | X20600080000  | X20600080000 | X20600080000 |    |
| 30 | Vrut do hmoždinky 4x40                      | 6 | ø4x40    | CSD2-100/110/120 | X94000040400  | X94000040400 | X94000040400 |    |
| 31 | Pevná stěna - CSD2 100                      | 1 |          | CSD2-100         | XNDCRPS11940  | XNDCRPSX1940 | XNDCRPSU1940 |    |
| 31 | Pevná stěna - CSD2 110                      | 1 |          | CSD2-110         | XNDCRPS12940  | XNDCRPSX2940 | XNDCRPSU2940 |    |
| 31 | Pevná stěna - CSD2 120                      | 1 |          | CSD2-120         | XNDCRPS13940  | XNDCRPSX3940 | XNDCRPSU3940 |   |
| 32 | Dveře - CSD2                                | 1 |          | CSD2-100/110/120 | XNDCRDV16610  | XNDCRDVX6610 | XNDCRDVU6610 |  |
| 40 | Madlo Chrome 3 komplet vč. Obalu            | 2 | set      | CSD2-100/110/120 | X3CRMAD3000A  | X3CRMAD3000A | X3CRMAD3000A |   |
| 41 | Madlo CHROME 1 vnitřní                      | 1 | 90x20x28 |                  | ↑set↑         | ↑set↑        | ↑set↑        |  |
| 42 | Madlo CHROME 1 vnější                       | 1 | 90x20x28 |                  | ↑set↑         | ↑set↑        | ↑set↑        |  |
| 43 | Podložka madla CHROME 1                     | 2 |          |                  | ↑set↑         | ↑set↑        | ↑set↑        |  |
| 44 | Šroub M4x30 DIN 912 A2 nerez                | 1 | M4x30    |                  | ↑set↑         | ↑set↑        | ↑set↑        |  |
| 45 | Krytka nerez pro madlo CHROME 1             | 1 | 24x14    |                  | ↑set↑         | ↑set↑        | ↑set↑        |  |

|    |                                     |   |          |                  |               |               |               |   |
|----|-------------------------------------|---|----------|------------------|---------------|---------------|---------------|---|
| 40 | Sada madlo CHROME 3                 | 1 | set      | CSD2-100/110/120 | X3CRMAD3000A  | X3CRMAD3000A  | X3CRMAD3000A  |    |
| 41 | Madlo CHROME 3 vnitřní              | 1 | 95x30x29 |                  | ↑set↑         | ↑set↑         | ↑set↑         |    |
| 42 | Madlo CHROME 3 vnější               | 1 | 95x30x29 |                  | ↑set↑         | ↑set↑         | ↑set↑         |    |
| 43 | Podložka madla CHROME 3             | 2 |          |                  | ↑set↑         | ↑set↑         | ↑set↑         |    |
| 44 | Šroub M4x30 DIN 912 A2 nerez        | 1 | M4x40    |                  | ↑set↑         | ↑set↑         | ↑set↑         |    |
| 45 | Krytka nerez pro madlo CHROME 1     | 4 | 24x14    |                  | ↑set↑         | ↑set↑         | ↑set↑         |    |
|    |                                     |   |          |                  |               |               |               |   |
| 50 | Vzpěra krátká Chrome 80,90          | 1 | set      | CSD2-100         | X3CRVZ249000A | X3CRVZ249000A | X3CRVZ249000A |   |
| 51 | Tyčka vřpěry krátká                 | 1 | 249      |                  | ↑set↑         | ↑set↑         | ↑set↑         |    |
| 52 | Úchyt vřpěry - zed'                 | 1 |          |                  | ↑set↑         | ↑set↑         | ↑set↑         |    |
| 53 | Úchyt vřpěry - sklo                 | 1 |          |                  | ↑set↑         | ↑set↑         | ↑set↑         |    |
| 54 | Koncovka tyčky vřpěry               | 2 |          |                  | ↑set↑         | ↑set↑         | ↑set↑         |    |
| 55 | Šroub samořez 3,5x20 DIN 7982 nerez | 2 | ø3,5x20  |                  | ↑set↑         | ↑set↑         | ↑set↑         |    |
| 56 | Krytka nerez pro vřpěru             | 1 | 26x14    |                  | ↑set↑         | ↑set↑         | ↑set↑         |    |
| 57 | Šroub M4x12 DIN965 nerez A2         | 2 | ø4x12    |                  | ↑set↑         | ↑set↑         | ↑set↑         |   |
| 58 | Stavěcí šroub M8x8 DIN 913 nerez A2 | 1 | ø8x8     |                  | ↑set↑         | ↑set↑         | ↑set↑         |  |
|    |                                     |   |          |                  |               |               |               |   |
| 50 | Vzpěra dlouhá Chrome 100,110,120    | 2 | set      | CSD2-110/120     | X3CRVZ320000A | X3CRVZ320000A | X3CRVZ320000A |   |
| 51 | Tyčka vřpěry dlouhá                 | 1 | 320      |                  | ↑set↑         | ↑set↑         | ↑set↑         |  |
| 52 | Úchyt vřpěry - zed'                 | 1 |          |                  | ↑set↑         | ↑set↑         | ↑set↑         |  |
| 53 | Úchyt vřpěry - sklo                 | 1 |          |                  | ↑set↑         | ↑set↑         | ↑set↑         |  |
| 54 | Koncovka tyčky vřpěry               | 2 |          |                  | ↑set↑         | ↑set↑         | ↑set↑         |  |
| 55 | Šroub samořez 3,5x20 DIN 7982 nerez | 2 | ø3,5x20  |                  | ↑set↑         | ↑set↑         | ↑set↑         |  |

|    |                                     |   |       |  |       |       |       |   |
|----|-------------------------------------|---|-------|--|-------|-------|-------|---|
| 56 | Krytka nerez pro vzpěru             | 1 | 26x14 |  | ↑set↑ | ↑set↑ | ↑set↑ |  |
| 57 | Šroub M4x12 DIN965 nerez A2         | 2 | ø4x12 |  | ↑set↑ | ↑set↑ | ↑set↑ |  |
| 58 | Stavěcí šroub M8x8 DIN 913 nerez A2 | 1 | ø8x8  |  | ↑set↑ | ↑set↑ | ↑set↑ |  |







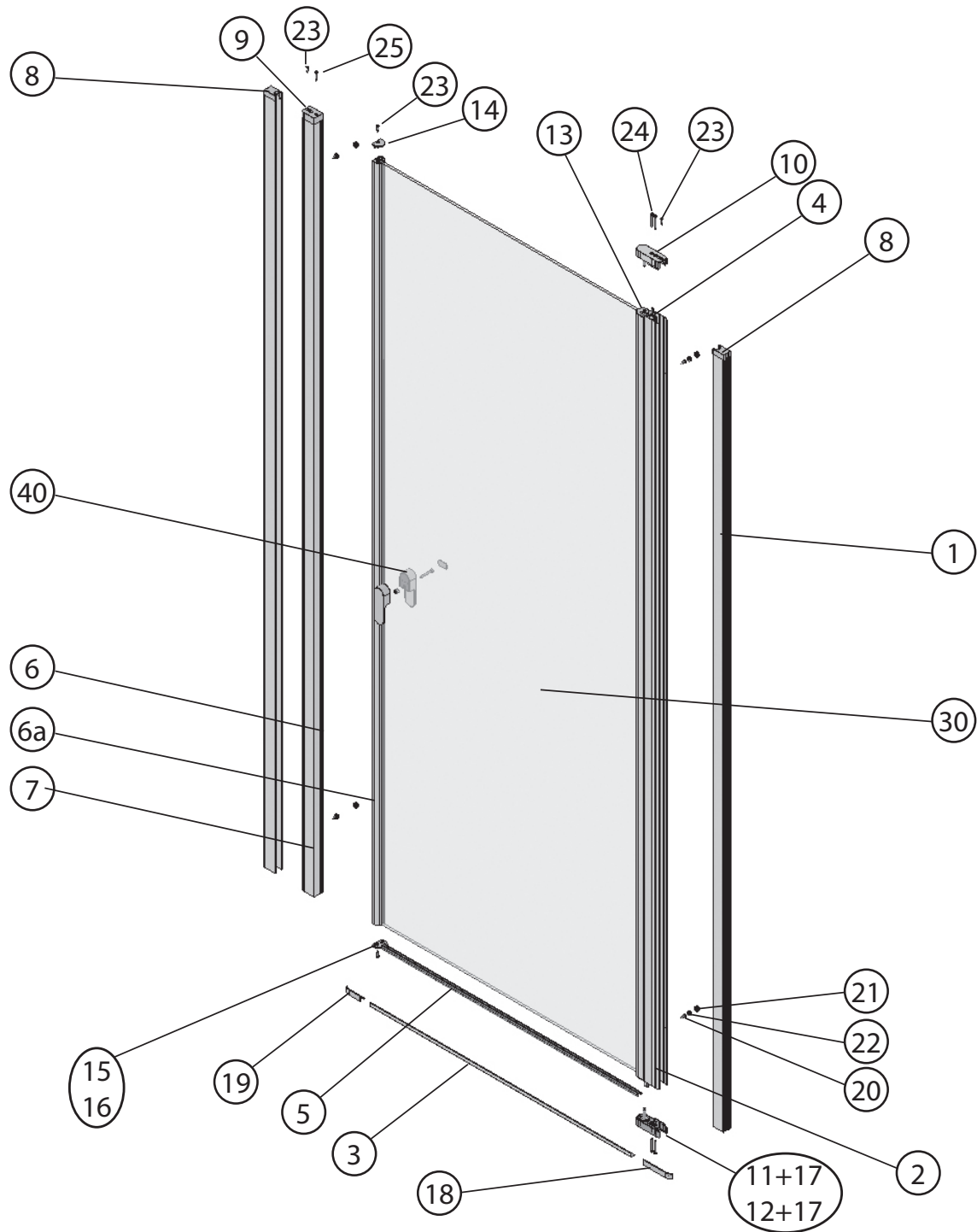



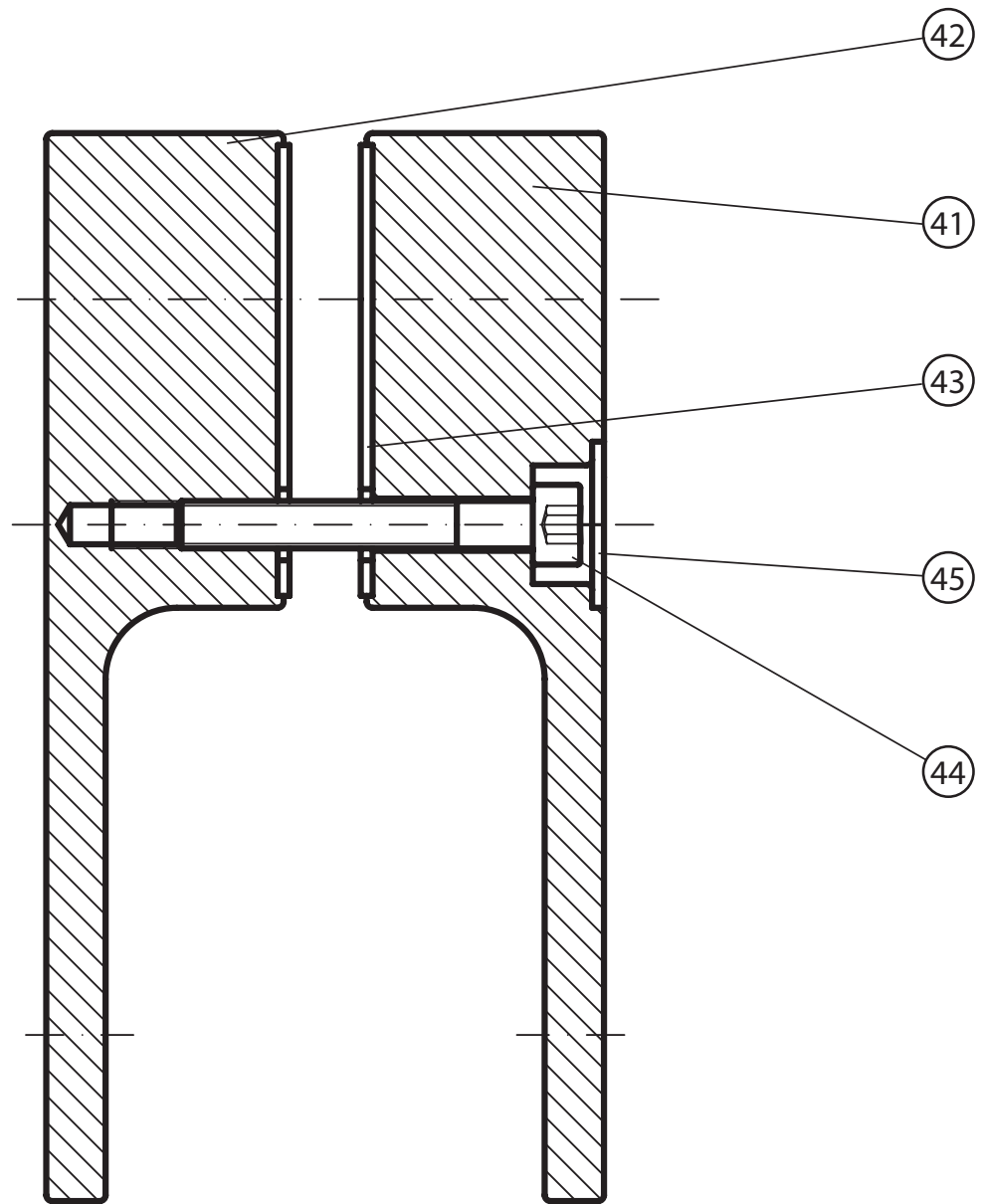











# CSD1 - 80, 90













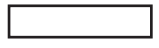
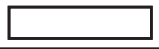



40



| <b>CSD1 - 80,90</b> |   |                |              |              |               |               |               |   |
|---------------------|---|----------------|--------------|--------------|---------------|---------------|---------------|---|
|                     | Název:  | Množství [ks]: | Rozměr [mm]: | Pro výrobek: | SIČ bílá:     | SIČ elox:     | SIČ bright:   | Obrázek:  |
| 1                   | Ustavovací profil Chrome zesílený LR14698/01 1934   | 2              | 1934         | CSD1-80/90   | XVE6980111934 | XVE69801X1934 | XVE69801U1934 |    |
| 2                   | Svislý profil dveře Chrome LR12246                  | 1              | 1918         | CSD1-80/90   | XVC2460111918 | XVC24601X1918 | XVC24601U1918 |    |
| 3                   | Prahová lišta Chrome rovná Bright 655               | 1              | 655          | CSD1-80/90   | XVC40804U0655 |               |               |    |
| 3                   | Prahová lišta Chrome rovná Bright 755               | 1              | 755          | CSD1-80/90   | XVC40805U0755 |               |               |    |
| 4                   | Svislý těsnící profil CHROME dl.1938 mm             | 2              | 1938         | CSD1-80/90   | X8CRPL0301938 |               |               |    |
| 5                   | Vodorovná ostřížková lišta CHROME dl.637mm          | 1              | 637          | CSD1-80/90   | X8CRPL0310637 |               |               |    |
| 5                   | Vodorovná ostřížková lišta CHROME dl.737mm          | 1              | 737          | CSD1-80/90   | X8CRPL0310737 |               |               |    |
| 6                   | Magnet ILPEA C0921 dl.1909 mm                       | 2              | 1909         | CSD1-80/90   | X6C092101909  |               |               |    |
| 6a                  | Svislý magnetový profil přímý LR15427/01 white 1909 | 1              | 1909         | CSD1-80/90   | XVF4270111909 | XVF42701X1909 | XVF42701U1909 |   |
| 7                   | Svislý magnetový profil CHROME LR12248              | 1              | 1934         | CSD1-80/90   | XVC2480111934 | XVC24801X1934 | XVC24801U1934 |    |
| 8                   | Krycí plast ust. profilu CR-PL-001                  | 2              |              | CSD1-80/90   | X8CRPL001000A |               |               |    |
| 9                   | Krycí plast profilu CR-PL-003                       | 1              |              | CSD1-80/90   | X8CRPL003000A |               |               |    |
| 10                  | Hlavní plast horní 2D CR-PL-006-010                 | 1              |              | CSD1-80/90   | X8CRZA016010A |               |               |    |
| 11                  | Hlavní plast spodní 2D levý CR-PL-006-02L           | 1              |              | CSD1-80/90   | X8CRPL00602LA |               |               |    |
| 12                  | Hlavní plast spodní 2D pravý CR-PL-006-02P          | 1              |              | CSD1-80/90   | X8CRPL00602PA |               |               |   |
| 13                  | Krycí plast profilu CR-PL-007 / čep                 | 2              |              | CSD1-80/90   | X8CRPL0070001 |               |               |  |
| 14                  | Krycí plast profilu horní CR-PL-008-010             | 1              |              | CSD1-80/90   | X8CRPL008010A |               |               |  |
| 15                  | Krycí plast profilu spodní levý CR-PL-008-02L       | 1              |              | CSD1-80/90   | X8CRPL00802LO |               |               |  |
| 16                  | Krycí plast profilu spodní pravý CR-PL-008-02P      | 1              |              | CSD1-80/90   | X8CRPL00802PO |               |               |  |
| 17                  | Zdvihací vložka stavitelná CR-PL-013                | 1              |              | CSD1-80/90   | X8CRPL0130001 |               |               |  |
| 18                  | Koncovka prahové lišty D2 levá CR-PL-053-01L        | 1              |              | CSD1-80/90   | X8CRPL05301LA |               |               |  |

|    |   |   |          |            |               |              |              |   |
|----|---|---|----------|------------|---------------|--------------|--------------|---|
| 18 | Koncovka prahové lišty D2 pravá CR-PL-053-01P | 1 |          | CSD1-80/90 | X8CRPL05301PA |              |              |    |
| 19 | Koncovka pr. lišty NIKA levá CR-PL-054-01L    | 1 |          | CSD1-80/90 | X8CRPL05401LA |              |              |    |
| 19 | Koncovka pr. lišty NIKA pravá CR-PL-054-01P   | 1 |          | CSD1-80/90 | X8CRPL05401PA |              |              |    |
| 20 | Podložka krytky - Transparent                 | 5 |          | CSD1-80/90 | X8A600000000  | X8A600000000 | X8BLPL157000 |    |
| 21 | Krytka šroubu                                 | 5 |          | CSD1-80/90 | X8A500000001  | X8A500000000 | X8BLPL15600A |    |
| 22 | Šroub samořezný 3,5x13 DIN 7981 A2 nerez      | 5 | ø3,5x13  | CSD1-80/90 | X97981035130  |              |              |    |
| 23 | Šroub samořez 3,5x13 DIN 7982 nerez           | 4 | ø3,5x13  | CSD1-80/90 | X97982035130  |              |              |    |
| 24 | Šroub samořez 3,5 x 32 DIN 7981 A2 nerez      | 4 | ø3,5x32  | CSD1-80/90 | X97981035320  |              |              |    |
| 25 | Šroub samořez 3,5 x 32 DIN 7982 A2 nerez      | 1 | ø3,5x32  | CSD1-80/90 | X97982035320  |              |              |    |
| 26 | Hmoždinka Ø 8                                 | 6 | ø8x40    | CSD1-80/90 | X20600080000  | X20600080000 | X20600080000 |    |
| 27 | Vrut do hmoždinky 4x40                        | 6 | ø4x40    | CSD1-80/90 | X94000040400  | X94000040400 | X94000040400 |    |
|    |   |   |          |            |               |              |              |   |
| 30 | Dveře - CSD1 80                               | 1 |          | CSD1-80    | XNDCRDV16610  | XNDCRDVX6610 | XNDCRDVU6610 |    |
| 30 | Dveře - CSD1 90                               | 1 |          | CSD1-90    | XNDCRDV17610  | XNDCRDVX7610 | XNDCRDVU7610 |    |
|    |   |   |          |            |               |              |              |   |
| 40 | Madlo Chrome 3 komplet vč. Obalu              | 2 | set      | CSD1-80/90 | X3CRMAD3000A  | X3CRMAD3000A | X3CRMAD3000A |   |
| 41 | Madlo CHROME 1 vnitřní                        | 1 | 90x20x28 |            | ↑set↑         | ↑set↑        | ↑set↑        |  |
| 42 | Madlo CHROME 1 vnější                         | 1 | 90x20x28 |            | ↑set↑         | ↑set↑        | ↑set↑        |  |
| 43 | Podložka madla CHROME 1                       | 2 |          |            | ↑set↑         | ↑set↑        | ↑set↑        |  |
| 44 | Šroub M4x30 DIN 912 A2 nerez                  | 1 | M4x30    |            | ↑set↑         | ↑set↑        | ↑set↑        |  |
| 45 | Krytka nerez pro madlo CHROME 1               | 1 | 24x14    |            | ↑set↑         | ↑set↑        | ↑set↑        |  |

|    |                                 |   |          |            |              |              |              |   |
|----|---------------------------------|---|----------|------------|--------------|--------------|--------------|---|
| 40 | Sada madlo CHROME 3             | 1 | set      | CSD1-80/90 | X3CRMAD3000A | X3CRMAD3000A | X3CRMAD3000A |  |
| 41 | Madlo CHROME 3 vnitřní          | 1 | 95x30x29 |            | ↑set↑        | ↑set↑        | ↑set↑        |  |
| 42 | Madlo CHROME 3 vnější           | 1 | 95x30x29 |            | ↑set↑        | ↑set↑        | ↑set↑        |  |
| 43 | Podložka madla CHROME 3         | 2 |          |            | ↑set↑        | ↑set↑        | ↑set↑        |  |
| 44 | Šroub M4x30 DIN 912 A2 nerez    | 1 | M4x40    |            | ↑set↑        | ↑set↑        | ↑set↑        |  |
| 45 | Krytka nerez pro madlo CHROME 1 | 4 | 24x14    |            | ↑set↑        | ↑set↑        | ↑set↑        |  |

# CPS - 80, 90, 100



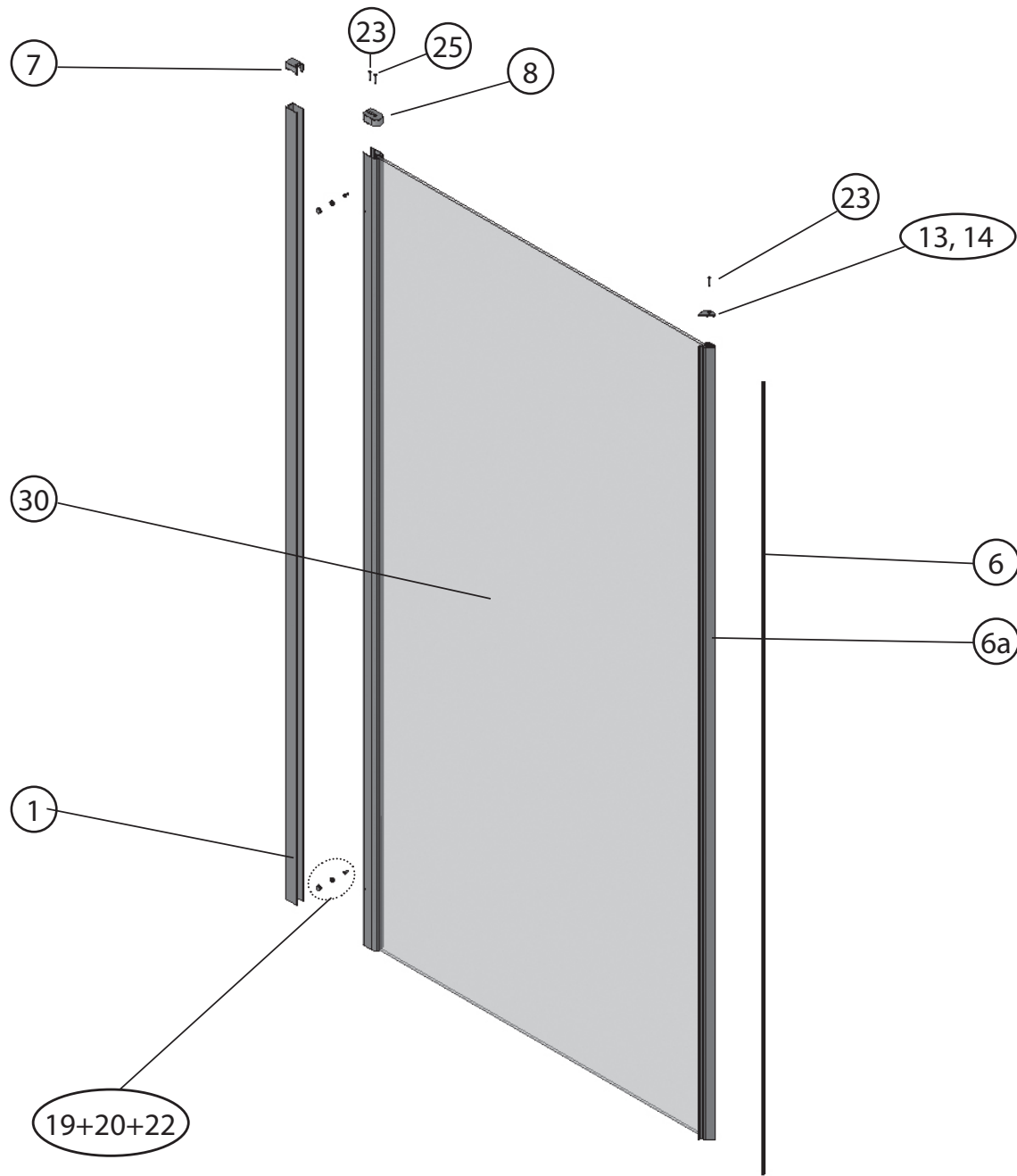





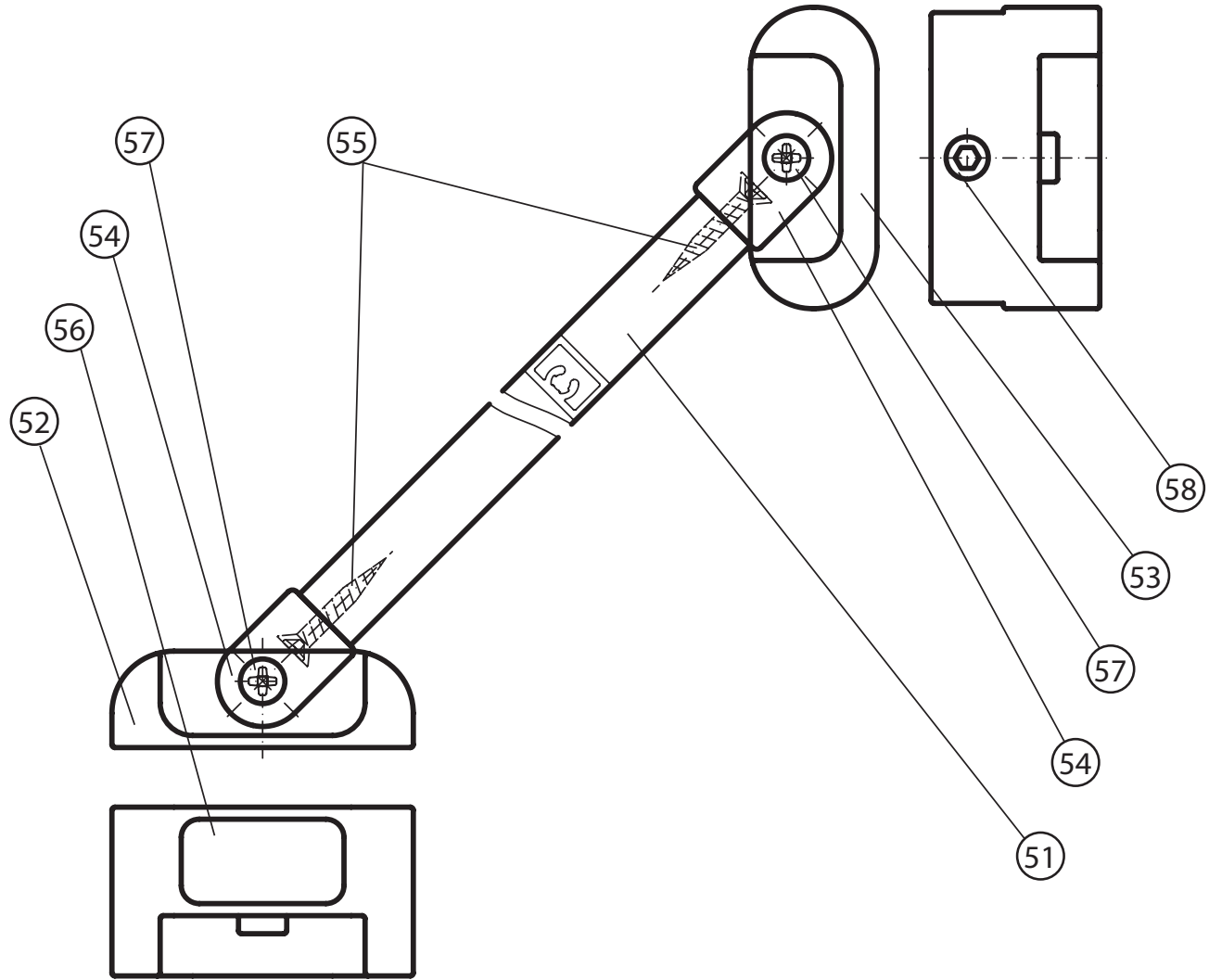























50



| <b>CPS - 80, 90,100</b> |  |                |              |               |               |               |               |   |
|-------------------------|--|----------------|--------------|---------------|---------------|---------------|---------------|---|
|                         | Název:   | Množství [ks]: | Rozměr [mm]: | Pro výrobek:  | SIČ bílá:     | SIČ elox:     | SIČ bright:   | Obrázek:  |
| 1                       | Ustavovací profil CHROME LR 12250                | 1              | 1927         | CPS-80/90/100 | XVC2500311927 | XVC25003X1927 | XVC25003U1927 |    |
| 6                       | Magnet ILPEA C0720 dl.1927 mm                    | 1              | 1927         | CPS-80/90/100 | X6C072001928  |               |               |    |
| 6a                      | Svislý magnetový profil 45 Chrome LR12245/1 1909 | 1              | 1927         | CPS-80/90/100 | XVF4260211927 | XVF42602X1927 | XVF42602U1927 |    |
| 7                       | Krycí plast ust. profilu CR-PL-001               | 1              |              | CPS-80/90/100 |               | X8CRPL001000A |               |    |
| 8                       | Krycí plast profilu CR-AL-002 - CR-PL-002        | 1              |              | CPS-80/90/100 |               | X8CRPL002000A |               |    |
| 13                      | Krycí plast profilu pravý CR-PL-009-01P          | 1              |              | CPS-80/90/100 |               | X8CRPL00901PA |               |    |
| 14                      | Krycí plast profilu levý CR-PL-009-01L           | 1              |              | CPS-80/90/100 |               | X8CRPL00901LA |               |    |
| 15                      | Koncovka prahové lišty PS levá CR-PL-055-01L     | 1              |              | CPS-80/90/100 |               | X8CRPL05501LA |               |    |
| 16                      | Koncovka prahové lišty PS pravá CR-PL-055-01P    | 1              |              | CPS-80/90/100 |               | X8CRPL05501PA |               |    |
| 19                      | Podložka krytky - Transparent                    | 2              |              | CPS-80/90/100 | X8A600000000  | X8A600000000  | X8BLPL157000  |    |
| 20                      | Krytka šroubu                                    | 2              |              | CPS-80/90/100 | X8A500000001  | X8A500000000  | X8BLPL15600A  |    |
| 22                      | Šroub samořezný 3,5x13 DIN 7981 A2 nerez         | 2              | ø3,5x13      | CPS-80/90/100 |               | X97981035130  |               |    |
| 23                      | Šroub samořez 3,5x13 DIN 7982 nerez              | 2              | ø3,5x13      | CPS-80/90/100 |               | X97982035130  |               |   |
| 25                      | Šroub samořez 3,5 x 32 DIN 7982 A2 nerez         | 1              | ø3,5x32      | CPS-80/90/100 |               | X97982035320  |               |  |
| 27                      | Hmoždinka Ø 8                                    | 3              | ø8x40        | CPS-80/90/100 | X20600080000  | X20600080000  | X20600080000  |  |
| 28                      | Vrūt do hmoždinky 4x40                           | 3              | ø4x40        | CPS-80/90/100 | X94000040400  | X94000040400  | X94000040400  |  |
| 30                      | Pevná stěna - CPS 80                             | 1              |              | CPS-80        | XNDCRPS17240  | XNDCRPSX7240  | XNDCRPSU7240  |  |
| 30                      | Pevná stěna - CPS 90                             | 1              |              | CPS-90        | XNDCRPS18240  | XNDCRPSX8240  | XNDCRPSU8240  |  |
| 30                      | Pevná stěna - CPS 100                            | 1              |              | CPS-100       | XNDCRPS19240  | XNDCRPSX9240  | XNDCRPSU9240  |  |

|    |                                     |   |         |           |               |               |               |   |
|----|-------------------------------------|---|---------|-----------|---------------|---------------|---------------|---|
| 50 | Vzpěra krátká Chrome 80,90          | 1 | set     | CPS-80/90 | X3CRVZ249000A | X3CRVZ249000A | X3CRVZ249000A |   |
| 51 | Tyčka vřpěry krátká                 | 1 | 249     |           | ↑set↑         | ↑set↑         | ↑set↑         |    |
| 52 | Úchyt vřpěry - zed'                 | 1 |         |           | ↑set↑         | ↑set↑         | ↑set↑         |    |
| 53 | Úchyt vřpěry - sklo                 | 1 |         |           | ↑set↑         | ↑set↑         | ↑set↑         |    |
| 54 | Koncovka tyčky vřpěry               | 2 |         |           | ↑set↑         | ↑set↑         | ↑set↑         |    |
| 55 | Šroub samořez 3,5x20 DIN 7982 nerez | 2 | ø3,5x20 |           | ↑set↑         | ↑set↑         | ↑set↑         |    |
| 56 | Krytka nerez pro vřpěru             | 1 | 26x14   |           | ↑set↑         | ↑set↑         | ↑set↑         |    |
| 57 | Šroub M4x12 DIN965 nerez A2         | 2 | ø4x12   |           | ↑set↑         | ↑set↑         | ↑set↑         |    |
| 58 | Stavěcí šroub M8x8 DIN 913 nerez A2 | 1 | ø8x8    |           | ↑set↑         | ↑set↑         | ↑set↑         |    |
|    |                                     |   |         |           |               |               |               |   |
| 50 | Vzpěra dlouhá Chrome 100            | 1 | set     | CPS-100   | X3CRVZ320000A | X3CRVZ320000A | X3CRVZ320000A |   |
| 51 | Tyčka vřpěry dlouhá                 | 1 | 320     |           | ↑set↑         | ↑set↑         | ↑set↑         |    |
| 52 | Úchyt vřpěry - zed'                 | 1 |         |           | ↑set↑         | ↑set↑         | ↑set↑         |    |
| 53 | Úchyt vřpěry - sklo                 | 1 |         |           | ↑set↑         | ↑set↑         | ↑set↑         |    |
| 54 | Koncovka tyčky vřpěry               | 2 |         |           | ↑set↑         | ↑set↑         | ↑set↑         |   |
| 55 | Šroub samořez 3,5x20 DIN 7982 nerez | 2 | ø3,5x20 |           | ↑set↑         | ↑set↑         | ↑set↑         |  |
| 56 | Krytka nerez pro vřpěru             | 1 | 26x14   |           | ↑set↑         | ↑set↑         | ↑set↑         |  |
| 57 | Šroub M4x12 DIN965 nerez A2         | 2 | ø4x12   |           | ↑set↑         | ↑set↑         | ↑set↑         |  |
| 58 | Stavěcí šroub M8x8 DIN 913 nerez A2 | 1 | ø8x8    |           | ↑set↑         | ↑set↑         | ↑set↑         |  |
|    |                                     |   |         |           |               |               |               |   |
|    |                                     |   |         |           |               |               |               |   |





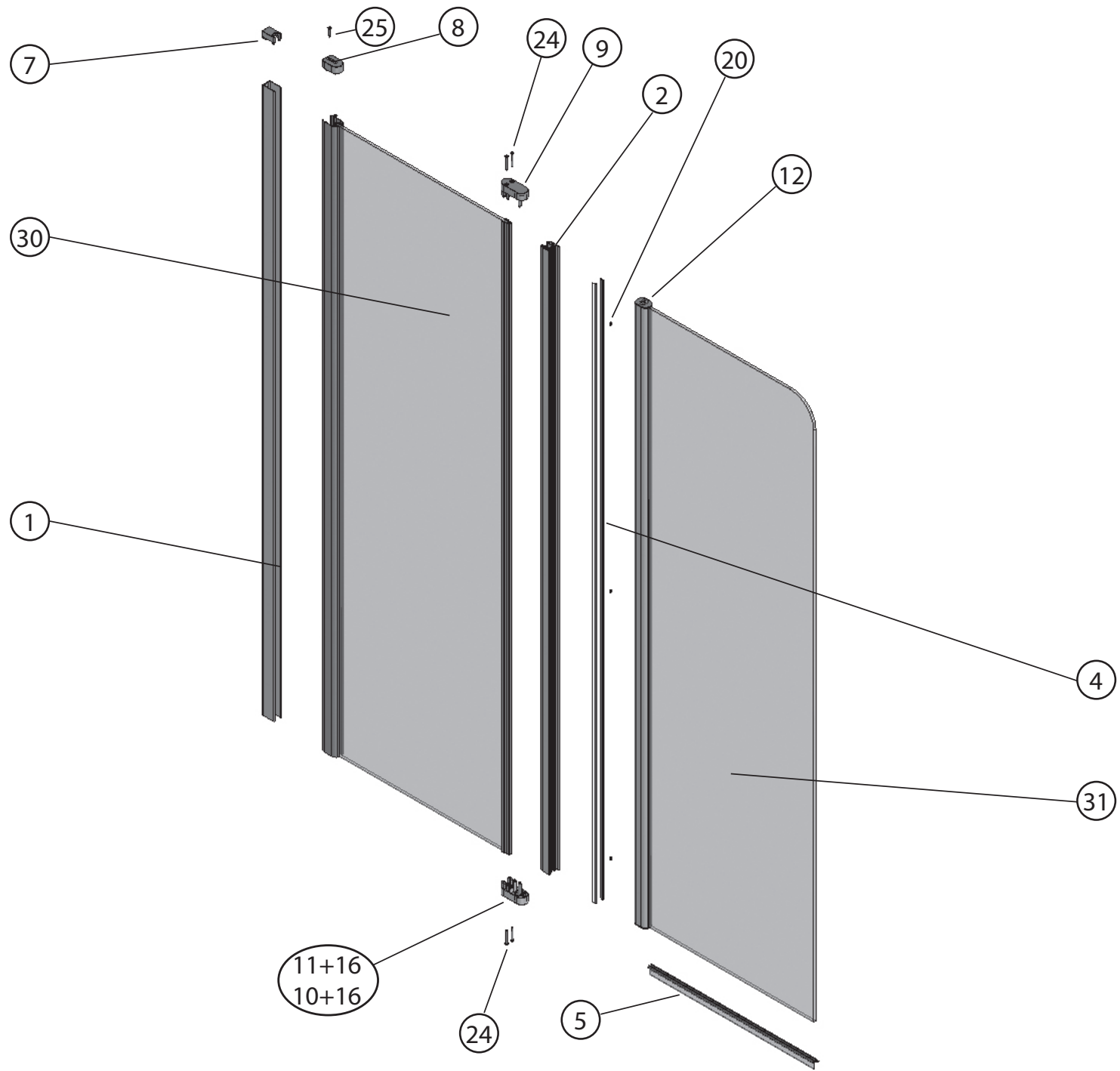



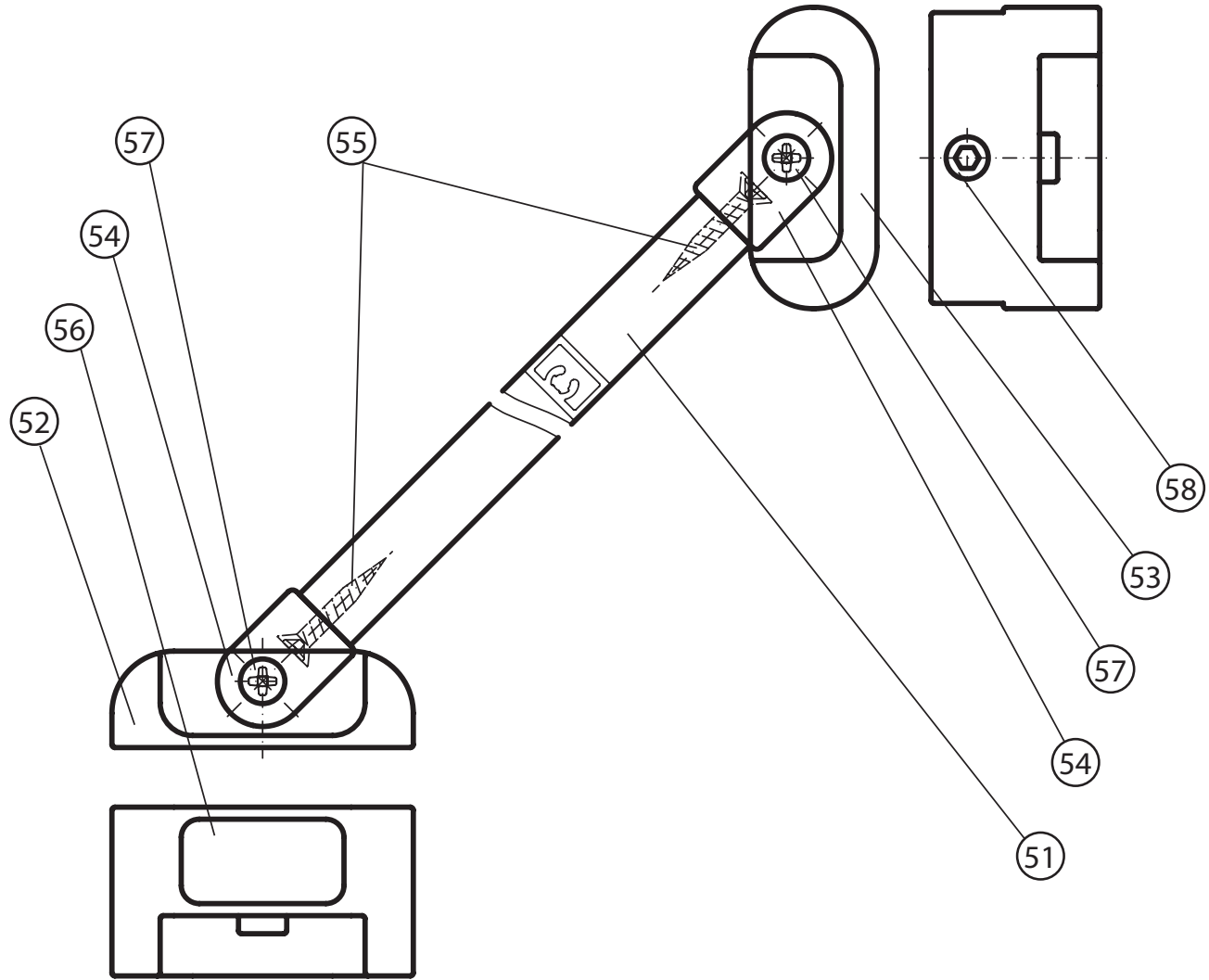











**CVS2-100L/R**  
**10°CVS2-100L/R**



















50



| <b>CVS2-100L/R - 10°CVS2-100L/R</b> |   |                |              |                 |               |               |               |   |
|-------------------------------------|---|----------------|--------------|-----------------|---------------|---------------|---------------|---|
|                                     | Název:                                      | Množství [ks]: | Rozměr [mm]: | Pro výrobek:    | SIČ bílá:     | SIČ elox:     | SIČ bright:   | Obrázek:  |
| 1                                   | Ustavovací profil CHROME LR 12250           | 1              | 1484         | CVS2-100 L/R    | XVC2500211484 | XVC25002X1484 | XVC25002U1484 |    |
| 1                                   | Ustavovací profil 10° CHROME LR14526        | 1              | 1484         | 10°CVS2-100 L/R | XVE5260111484 | XVE52601X1484 | XVE52601U1484 |    |
| 2                                   | Svislý profil dveří / PS CHROME dl. 1468    | 1              | 1468         | CVS2-100 L/R    | XVC2470211468 | XVC24702X1468 | XVC24702U1468 |    |
| 4                                   | Svislý těsnící profil dl.1488 mm            | 2              | 1488         | CVS2-100 L/R    | X8CRPL0301488 |               |               |    |
| 5                                   | Okapnička Rehau 656 715 dl. 462 mm pro CVS2 | 1              | 462          | CVS2-100 L/R    | X65671500023  |               |               |    |
|                                     |   |                |              |                 |               |               |               |   |
| 7                                   | Krycí plast ust. profilu CR-PL-001          | 1              |              | CVS2-100 L/R    | X8CRPL001000A |               |               |    |
| 7                                   | Krycí plast ust. profilu 10° CR-PL-001-02L  | 1              |              | 10°CVS1-100 L   | X8CRPL00102LA |               |               |    |
| 7                                   | Krycí plast ust. profilu 10° CR-PL-001-02P  | 1              |              | 10°CVS1-100R    | X8CRPL00102PA |               |               |    |
| 8                                   | Krycí plast profilu CR-PL-002               | 1              |              | CVS2-100 L/R    | X8CRPL002000A |               |               |    |
| 9                                   | Hlavní plast horní 4D CR-PL-005-010         | 1              |              | CVS2-100 L/R    | X8CRZA015010A |               |               |    |
| 10                                  | Hlavní plast spodní 4D levý CR-PL-005-02L   | 1              |              | CVS2-100 L/R    | X8CRPL00502LA |               |               |    |
| 11                                  | Hlavní plast spodní 4D pravý CR-PL-005-02P  | 1              |              | CVS2-100 L/R    | X8CRPL00502PA |               |               |   |
| 12                                  | Krycí plast profilu CR-PL-007 / čep         | 2              |              | CVS2-100 L/R    | X8CRPL0070001 |               |               |  |
| 16                                  | Zdvihací vložka stavitelná CR-PL-013        | 1              |              | CVS2-100 L/R    | X8CRPL0130001 |               |               |  |
| 19                                  | Podložka krytky - Transparent               | 2              |              | CVS2-100 L/R    | X8A600000000  | X8A600000000  | X8BLPL157000  |  |
| 20                                  | Krytka šroubu                               | 2              |              | CVS2-100 L/R    | X8A500000001  | X8A500000000  | X8BLPL15600A  |  |
| 22                                  | Šroub samořezný 3,5x13 DIN 7981 A2 nerez    | 5              | ø3,5x13      | CVS2-100 L/R    | X97981035130  |               |               |  |
| 23                                  | Šroub samořez 3,5x13 DIN 7982 nerez         | 1              | ø3,5x13      | CVS2-100 L/R    | X97982035130  |               |               |  |
| 24                                  | Šroub samořez 3,5 x 32 DIN 7981 A2 nerez    | 4              | ø3,5x32      | CVS2-100 L/R    | X97981035320  |               |               |  |
| 25                                  | Šroub samořez 3,5 x 32 DIN 7982 nerez       | 1              | ø3,5x32      | CVS2-100 L/R    | X97982035320  |               |               |  |









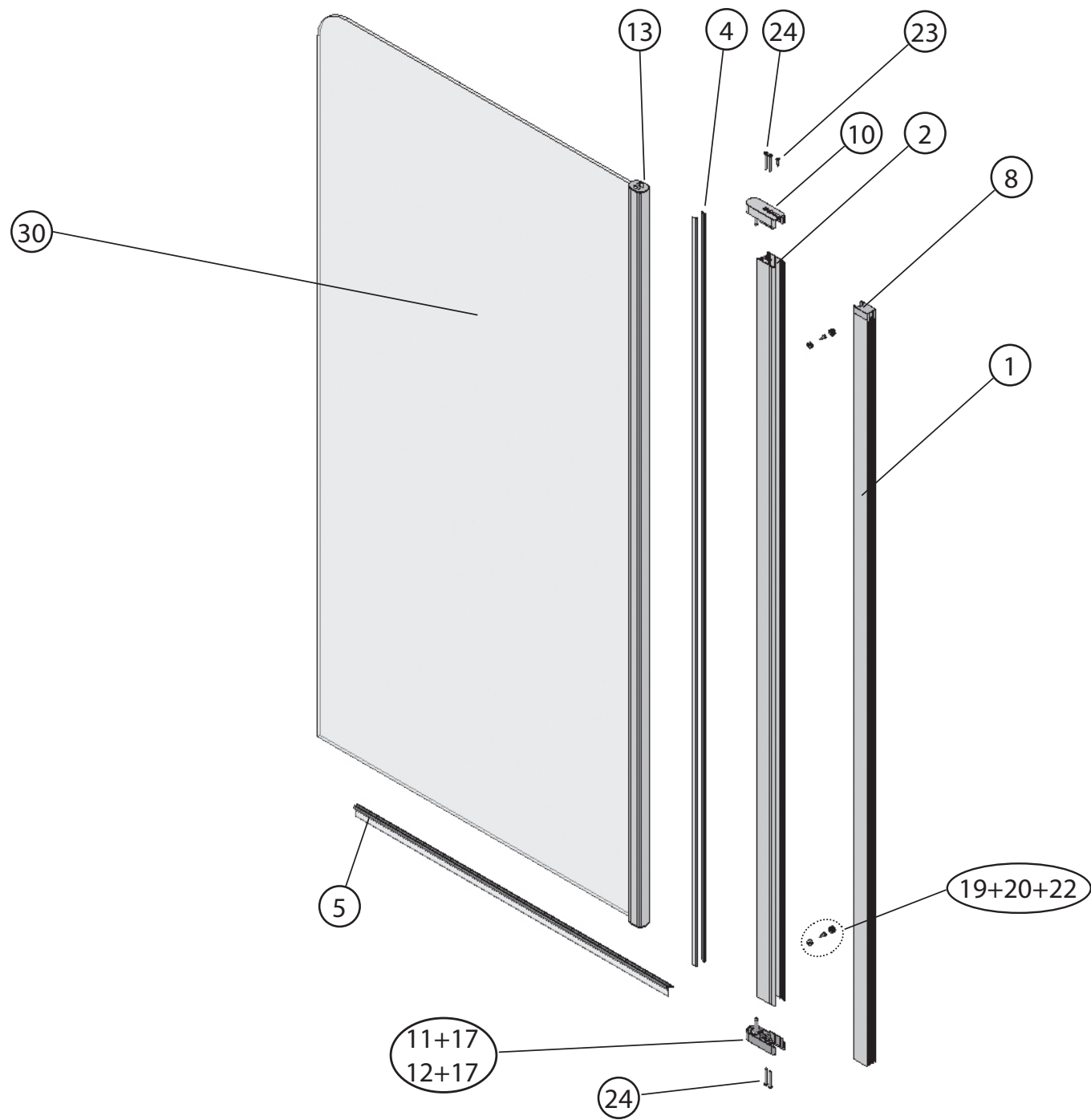













|    |                                     |   |         |              |               |               |               |   |
|----|-------------------------------------|---|---------|--------------|---------------|---------------|---------------|---|
| 27 | Hmoždinka Ø 8                       | 3 | ø8x40   | CVS2-100 L/R | X20600080000  | X20600080000  | X20600080000  |    |
| 28 | Vrut do hmoždinky 4x40              | 3 | ø4x40   | CVS2-100 L/R | X94000040400  | X94000040400  | X94000040400  |    |
|    |                                     |   |         |              |               |               |               |   |
| 30 | Pevná stěna - CVS2-100 L            | 1 |         | CVS2-100 L   | XNDCRPS14640  | XNDCRPSX4640  | XNDCRPSU4640  |    |
| 30 | Pevná stěna - CVS2-100 P            | 1 |         | CVS2-100 R   | XNDCRPS14640  | XNDCRPSX4640  | XNDCRPSU4640  |    |
| 31 | Dveře CVS2-100 L                    | 1 |         | CVS2-100 L   | XNDCRDV1459L  | XNDCRDVX459L  | XNDCRDVU459L  |    |
| 31 | Dveře CVS2-100 P                    | 1 |         | CVS2-100 R   | XNDCRDV1459P  | XNDCRDVX459P  | XNDCRDVU459P  |    |
|    |                                     |   |         |              |               |               |               |   |
| 50 | Vzpěra dlouhá Chrome                | 1 | set     | CVS2-100 L/R | X3CRVZ320000A | X3CRVZ320000A | X3CRVZ320000A |   |
| 51 | Tyčka vzpěry dlouhá                 | 1 |         |              | ↑set↑         | ↑set↑         | ↑set↑         |    |
| 52 | Úchyt vzpěry - zed'                 | 1 |         |              | ↑set↑         | ↑set↑         | ↑set↑         |    |
| 53 | Úchyt vzpěry - sklo                 | 1 |         |              | ↑set↑         | ↑set↑         | ↑set↑         |    |
| 54 | Koncovka tyčky vzpěry               | 2 |         |              | ↑set↑         | ↑set↑         | ↑set↑         |    |
| 55 | Šroub samořez 3,5x20 DIN 7982 nerez | 2 | ø3,5x20 |              | ↑set↑         | ↑set↑         | ↑set↑         |    |
| 56 | Krytka nerez pro vzpěru             | 1 | 26x14   |              | ↑set↑         | ↑set↑         | ↑set↑         |   |
| 57 | Šroub M4x12 DIN965 nerez A2         | 2 | ø4x12   |              | ↑set↑         | ↑set↑         | ↑set↑         |  |
| 58 | Stavěcí šroub M8x8 DIN 913 nerez A2 | 1 | ø8x8    |              | ↑set↑         | ↑set↑         | ↑set↑         |  |
|    |                                     |   |         |              |               |               |               |   |



# CVS1 80 L/R - 10° CVS1 80L/R





| <b>CVS1 80 L/R - 10°CVS1 80L/R</b> |   |                |              |                 |               |               |               |   |
|------------------------------------|---|----------------|--------------|-----------------|---------------|---------------|---------------|---|
|                                    | Název:                                      | Množství [ks]: | Rozměr [mm]: | Pro výrobek:    | SIČ bílá:     | SIČ elox:     | SIČ bright:   | Obrázek:  |
| 1                                  | Ustavovací profil CHROME LR 12250           | 1              | 1484         | CVS1-80, L / R  | XVC2500211484 | XVC25002X1484 | XVC25002U1484 |    |
| 1                                  | Ustavovací profil 10° CHROME LR14526        | 1              | 1484         | 10°CVS2-100 L/R | XVE5260111484 | XVE52601X1484 | XVE52601U1484 |    |
| 2                                  | Svislý profil dveře Chrome LR12246          | 1              | 1468         | CVS1-80, L / R  | XVC2460211468 | XVC24602X1468 | XVC24602U1468 |    |
| 4                                  | Svislý těsnící profil CHROME dl.1488 mm     | 2              | 1488         | CVS1-80, L / R  | X8CRPL0301488 |               |               |    |
| 5                                  | Vodorovná ostříkovaná lišta CHROME dl.727mm | 1              | 727          | CVS1-80, L / R  | X8CRPL0310727 |               |               |    |
| 8                                  | Krycí plast ust. profilu CR-PL-001          | 1              |              | CVS1-80, L / R  | X8CRPL001000A |               |               |    |
| 8                                  | Krycí plast ust. profilu 10° CR-PL-001-02L  | 1              |              | 10°CVS1-100 L   | X8CRPL00102LA |               |               |    |
| 8                                  | Krycí plast ust. profilu 10° CR-PL-001-02P  | 1              |              | 10°CVS1-100 R   | X8CRPL00102PA |               |               |    |
| 10                                 | Hlavní plast horní 2D CR-PL-006-010         | 1              |              | CVS1-80, L / R  | X8CRZA016010A |               |               |    |
| 11                                 | Hlavní plast spodní 2D levý CR-PL-006-02L   | 1              |              | CVS1-80, L / R  | X8CRPL00602LA |               |               |    |
| 12                                 | Hlavní plast spodní 2D pravý CR-PL-006-02P  | 1              |              | CVS1-80, L / R  | X8CRPL00602PA |               |               |    |
| 13                                 | Krycí plast profilu CR-PL-007 / čep         | 2              |              | CVS1-80, L / R  | X8CRPL0070001 |               |               |    |
| 17                                 | Zdvíhací vložka stavitelná CR-PL-013        | 1              |              | CVS1-80, L / R  | X8CRPL0130001 |               |               |   |
| 19                                 | Podložka krytky - Transparent               | 2              |              | CVS1-80, L / R  | X8A600000000  | X8A600000000  | X8BLPL157000  |  |
| 20                                 | Krytka šroubu                               | 2              |              | CVS1-80, L / R  | X8A500000001  | X8A500000000  | X8BLPL15600A  |  |
| 22                                 | Šroub samořezný 3,5x13 DIN 7981 A2 nerez    | 2              | ø3,5x13      | CVS1-80, L / R  | X97981035130  |               |               |  |
| 23                                 | Šroub samořez 3,5x13 DIN 7982 nerez         | 1              | ø3,5x13      | CVS1-80, L / R  | X97982035130  |               |               |  |
| 24                                 | Šroub samořez 3,5 x 32 DIN 7981 A2 nerez    | 2              | ø3,5x32      | CVS1-80, L / R  | X97981035320  |               |               |  |
| 26                                 | Hmoždinka Ø 8                               | 3              | ø8x40        | CVS1-80, L / R  | X20600080000  | X20600080000  | X20600080000  |  |
| 27                                 | Vrut do hmoždinky 4x40                      | 3              | ø4x40        | CVS1-80, L / R  | X94000040400  | X94000040400  | X94000040400  |  |
| 30                                 | Dveře - CVS1 80L                            | 1              |              | CVS1-80L        | XNDCRDV1729L  | XNDCRDVX729L  | XNDCRDVU729L  |  |
| 30                                 | Dveře - CVS1 80R                            | 1              |              | CVS1-80R        | XNDCRDV1729P  | XNDCRDVX729P  | XNDCRDVU729P  |  |





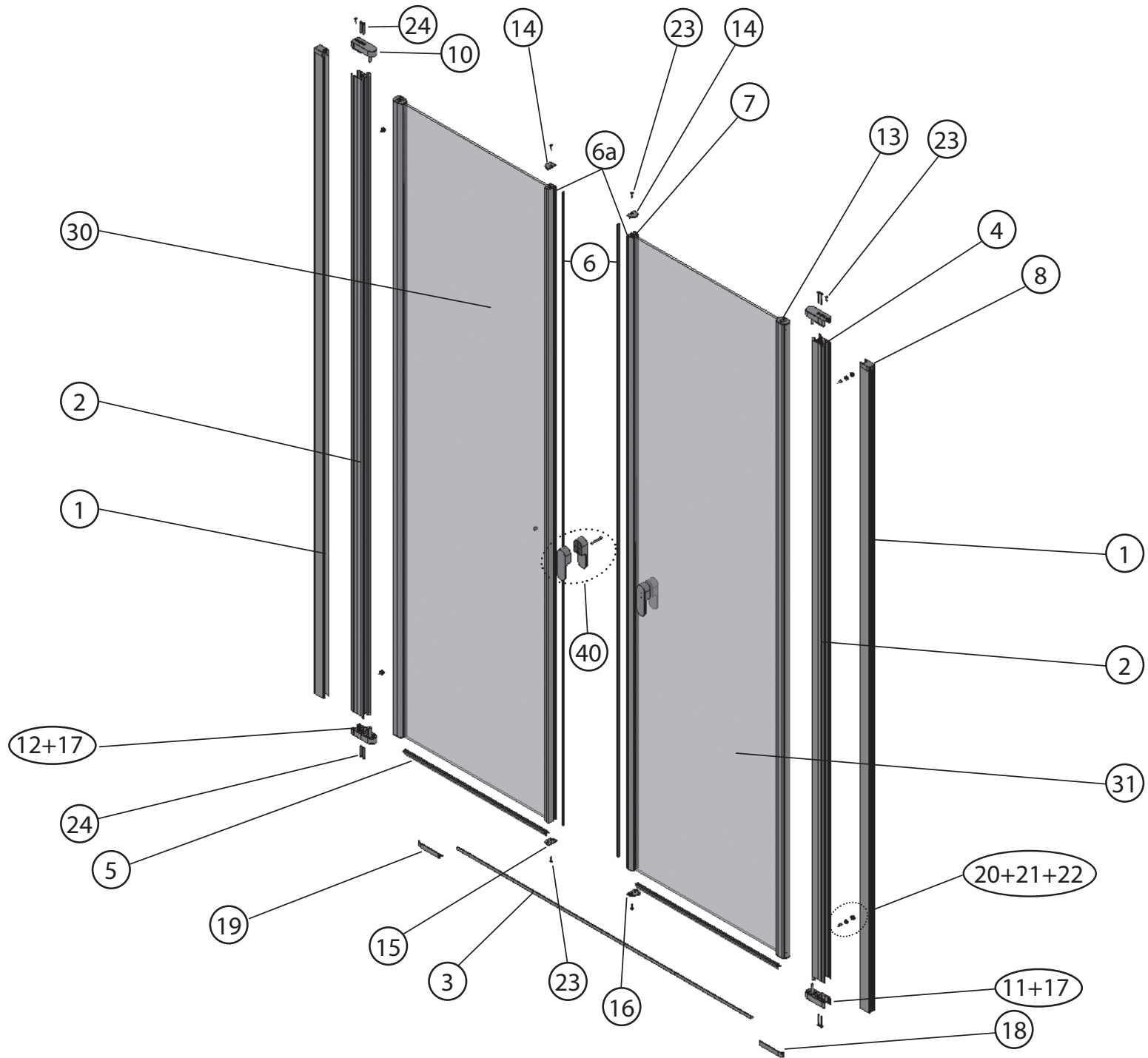



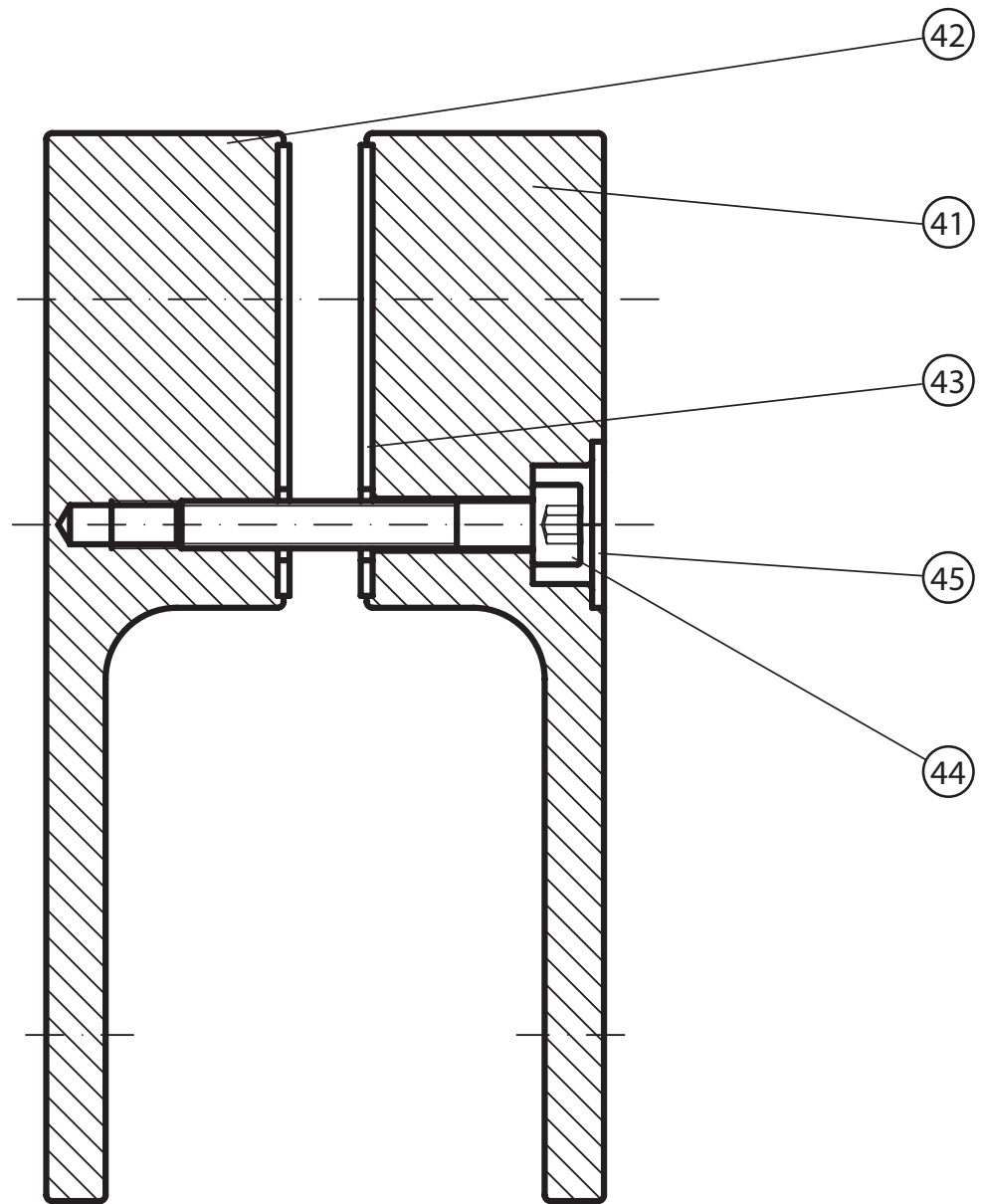











# CSDL2 - 120













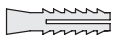

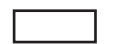



40



| <b>CSDL2 - 20</b> |   |                |              |              |               |               |               |   |
|-------------------|---|----------------|--------------|--------------|---------------|---------------|---------------|---|
|                   | Název:  | Množství [ks]: | Rozměr [mm]: | Pro výrobek: | SIČ bílá:     | SIČ elox:     | SIČ bright:   | Obrázek:  |
| 1                 | Ustavovací profil Chrome zesílený LR14698/01 1934   | 2              | 1934         | CSDL2-120    | XVE6980111934 | XVE69801X1934 | XVE69801U1934 |    |
| 2                 | Svislý profil dveře Chrome LR12246                  | 2              | 1918         | CSDL2-120    | XVC2460111918 | XVC24601X1918 | XVC24601U1918 |    |
| 3                 | Prahová lišta Chrome rovná Bright 1022              | 1              | 1022         | CSDL2-120    | XVC40807U1022 |               |               |    |
| 4                 | Svislý těsnící profil CHROME dl.1938 mm             | 4              | 1938         | CSDL2-120    | X8CRPL0301938 |               |               |    |
| 5                 | Vodorovná ostříkovaná lišta CHROME dl.492 mm        | 2              | 492          | CSDL2-120    | X8CRPL0310492 |               |               |    |
| 6                 | Magnet ILPEA C0921 dl.1909 mm                       | 2              | 1909         | CSDL2-120    | X6C092101909  |               |               |    |
| 6a                | Svislý magnetový profil přímý LR15427/01 white 1909 | 2              | 1909         | CSDL2-120    | XVF4270111909 | XVF42701X1909 | XVF42701U1909 |   |
| 7                 | Svislý magnetový profil CHROME LR12248              | 2              | 1934         | CSDL2-120    | XVC2480111934 | XVC24801X1934 | XVC24801U1934 |    |
| 8                 | Krycí plast ust. profilu CR-PL-001                  | 2              |              | CSDL2-120    | X8CRPL001000A |               |               |    |
| 10                | Hlavní plast horní 2D CR-PL-006-010                 | 2              |              | CSDL2-120    | X8CRZA016010A |               |               |    |
| 11                | Hlavní plast spodní 2D levý CR-PL-006-02L           | 1              |              | CSDL2-120    | X8CRPL00602LA |               |               |    |
| 12                | Hlavní plast spodní 2D pravý CR-PL-006-02P          | 1              |              | CSDL2-120    | X8CRPL00602PA |               |               |    |
| 13                | Krycí plast profilu CR-PL-007 / čep                 | 4              |              | CSDL2-120    | X8CRPL0070001 |               |               |   |
| 14                | Krycí plast profilu horní CR-PL-008-010             | 2              |              | CSDL2-120    | X8CRPL008010A |               |               |  |
| 15                | Krycí plast profilu spodní levý CR-PL-008-02L       | 1              |              | CSDL2-120    | X8CRPL00802LO |               |               |  |
| 16                | Krycí plast profilu spodní pravý CR-PL-008-02P      | 1              |              | CSDL2-120    | X8CRPL00802PO |               |               |  |
| 17                | Zdvíhací vložka stavitelná CR-PL-013                | 2              |              | CSDL2-120    | X8CRPL0130001 |               |               |  |
| 18                | Koncovka prahové lišty D2 levá CR-PL-053-01L        | 1              |              | CSDL2-120    | X8CRPL05301LA |               |               |  |
| 19                | Koncovka prahové lišty D2 pravá CR-PL-053-01P       | 1              |              | CSDL2-120    | X8CRPL05301PA |               |               |  |
| 20                | Podložka krytky - Transparent                       | 4              |              | CSD1-80/90   | X8A600000000  | X8A600000000  | X8BLPL157000  |  |
| 21                | Krytka šroubu                                       | 4              |              | CSD1-80/90   | X8A500000001  | X8A500000000  | X8BLPL15600A  |  |









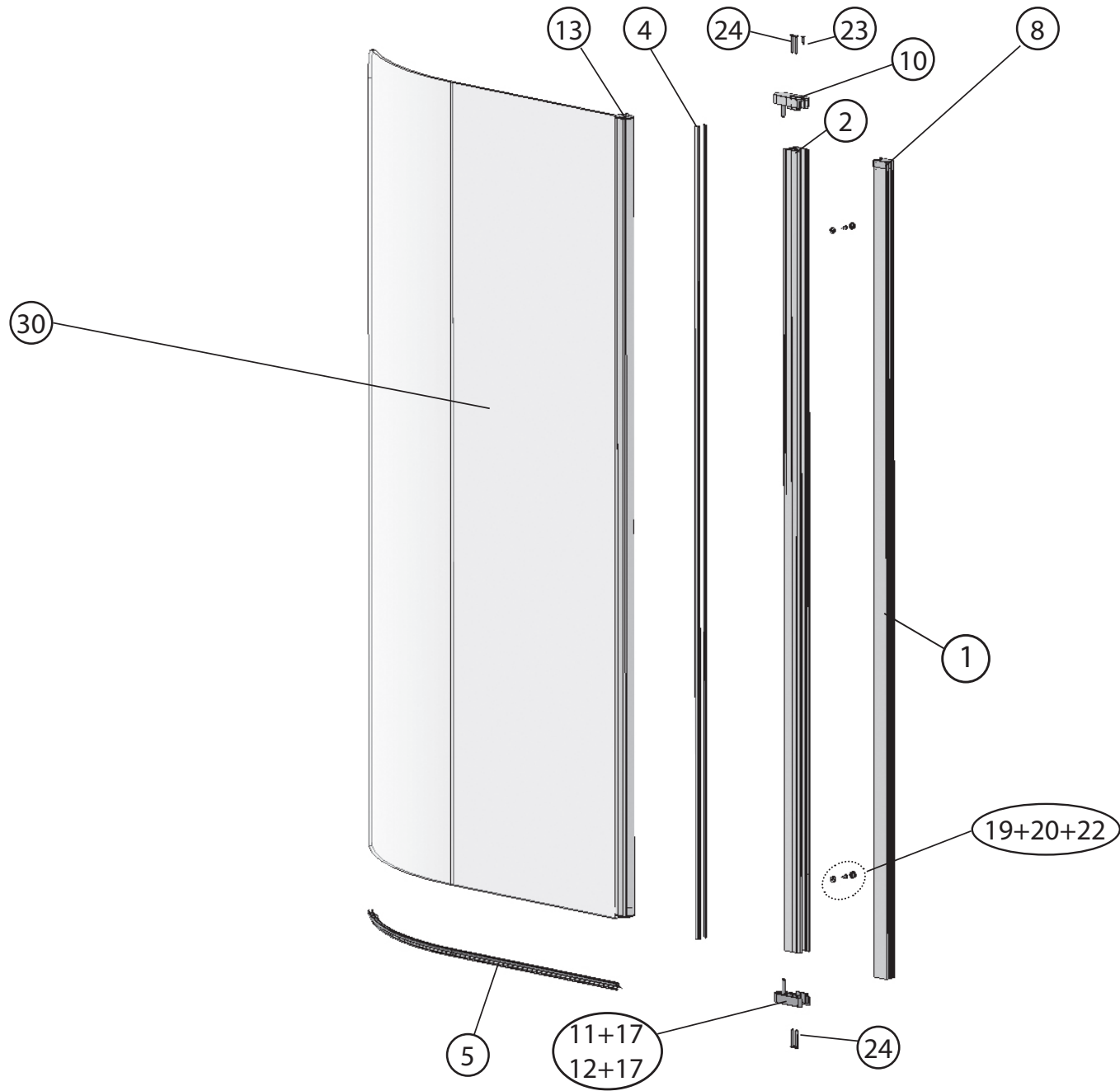











|    |  |   |          |           |              |              |              |   |
|----|--|---|----------|-----------|--------------|--------------|--------------|---|
| 22 | Šroub samořezný 3,5x13 DIN 7981 A2 nerez | 4 | ø3,5x13  | CSDL2-120 | X97981035130 |              |              |    |
| 23 | Šroub samořez 3,5x13 DIN 7982 nerez      | 6 | ø3,5x13  | CSDL2-120 | X97982035130 |              |              |    |
| 24 | Šroub samořez 3,5 x 32 DIN 7981 A2 nerez | 8 | ø3,5x32  | CSDL2-120 | X97981035320 |              |              |    |
| 26 | Hmoždinka Ø 8                            | 6 | ø8x40    | CSDL2-120 | X20600080000 | X20600080000 | X20600080000 |    |
| 27 | Vrut do hmoždinky 4x40                   | 6 | ø4x40    | CSDL2-120 | X94000040400 | X94000040400 | X94000040400 |    |
|    |  |   |          |           |              |              |              |   |
| 30 | Dveře - CSDL2-120L                       | 1 |          | CSDL2-120 | XNDCRDV15150 | XNDCRDVX5150 | XNDCRDVU5150 |    |
| 31 | Dveře - CSDL2-120R                       | 1 |          | CSDL2-120 | XNDCRDV15150 | XNDCRDVX5150 | XNDCRDVU5150 |    |
|    |  |   |          |           |              |              |              |   |
| 40 | Madlo Chrome 3 komplet vč. Obalu         | 2 | set      | CSDL2-120 | X3CRMAD3000A | X3CRMAD3000A | X3CRMAD3000A |   |
| 41 | Madlo CHROME 1 vnitřní                   | 1 | 90x20x28 |           | ↑set↑        | ↑set↑        | ↑set↑        |    |
| 42 | Madlo CHROME 1 vnější                    | 1 | 90x20x28 |           | ↑set↑        | ↑set↑        | ↑set↑        |    |
| 43 | Podložka madla CHROME 1                  | 2 |          |           | ↑set↑        | ↑set↑        | ↑set↑        |    |
| 44 | Šroub M4x30 DIN 912 A2 nerez             | 1 | M4x30    |           | ↑set↑        | ↑set↑        | ↑set↑        |    |
| 45 | Krytka nerez pro madlo CHROME 1          | 4 | 24x14    |           | ↑set↑        | ↑set↑        | ↑set↑        |    |
|    |  |   |          |           |              |              |              |   |
| 40 | Sada madlo CHROME 3                      | 2 | set      | CSDL2-120 | X3CRMAD3000A | X3CRMAD3000A | X3CRMAD3000A |   |
| 41 | Madlo CHROME 3 vnitřní                   | 1 | 95x30x29 |           | ↑set↑        | ↑set↑        | ↑set↑        |  |
| 42 | Madlo CHROME 3 vnější                    | 1 | 95x30x29 |           | ↑set↑        | ↑set↑        | ↑set↑        |  |
| 43 | Podložka madla                           | 2 |          |           | ↑set↑        | ↑set↑        | ↑set↑        |  |
| 44 | Šroub M4x30 DIN 912 A2 nerez             | 1 | M4x40    |           | ↑set↑        | ↑set↑        | ↑set↑        |  |
| 45 | Krytka nerez pro madlo CHROME 1          | 4 | 24x14    |           | ↑set↑        | ↑set↑        | ↑set↑        |  |
|    |  |   |          |           |              |              |              |   |



# CVSK1- 85, 100





| <b>CVSK1- 85, 100 L/R</b> |  |                |              |                      |               |               |               |   |
|---------------------------|--|----------------|--------------|----------------------|---------------|---------------|---------------|---|
|                           | Název:   | Množství [ks]: | Rozměr [mm]: | Pro výrobek:         | SIČ bílá:     | SIČ elox:     | SIČ bright:   | Obrázek:  |
| 1                         | Ustavovací profil CHROME LR 12250              | 1              | 1484         | CVSK1-85, 100, L / R | XVC2500211484 | XVC25002X1484 | XVC25002U1484 |    |
| 2                         | Svislý profil dveře Chrome LR12246             | 1              | 1468         | CVSK1-85, 100, L / R | XVC2460211468 | XVC24602X1468 | XVC24602U1468 |    |
| 4                         | Svislý těsnící profil CHROME dl.1488 mm        | 2              | 1488         | CVSK1-85, 100, L / R | X8CRPL0301488 |               |               |    |
| 5                         | Okapnička Rehau 656 715 dl. 775 mm pro CVSK1_L | 1              | 775          | CVSK1-85, L / R      | X65671500025  |               |               |    |
| 5                         | Okapnička Rehau 656 715 dl. 775 mm pro CVSK1_P | 1              | 775          | CVSK1-85, L / R      | X65671500026  |               |               |    |
| 5                         | Okapnička Rehau 656 715 dl. 925 mm pro CVSK1_L | 1              | 925          | CVSK1-100, L / R     | X65671500027  |               |               |    |
| 5                         | Okapnička Rehau 656 715 dl. 925 mm pro CVSK1_P | 1              | 925          | CVSK1-100, L / R     | X65671500028  |               |               |    |
| 8                         | Krycí plast ust. profilu CR-PL-001             | 1              |              | CVSK1-85, 100, L / R | X8CRPL001000A |               |               |    |
| 10                        | Hlavní plast horní 2D CR-PL-006-010            | 1              |              | CVSK1-85, 100, L / R | X8CRZA016010A |               |               |    |
| 11                        | Hlavní plast spodní 2D levý CR-PL-006-02L      | 1              |              | CVSK1-85, 100, L / R | X8CRPL00602LA |               |               |    |
| 12                        | Hlavní plast spodní 2D pravý CR-PL-006-02P     | 1              |              | CVSK1-85, 100, L / R | X8CRPL00602PA |               |               |    |
| 13                        | Krycí plast profilu CR-PL-007 / čep            | 2              |              | CVSK1-85, 100, L / R | X8CRPL0070001 |               |               |   |
| 17                        | Zdvíhací vložka stavitelná CR-PL-013           | 1              |              | CVSK1-85, 100, L / R | X8CRPL0130001 |               |               |  |
| 19                        | Podložka krytky - Transparent                  | 2              |              | CVSK1-85, 100, L / R | X8A600000000  | X8A600000000  | X8BLPL157000  |  |
| 20                        | Krytka šroubu                                  | 2              |              | CVSK1-85, 100, L / R | X8A500000001  | X8A500000000  | X8BLPL15600A  |  |
| 22                        | Šroub samořezný 3,5x13 DIN 7981 A2 nerez       | 2              | ø3,5x13      | CVSK1-85, 100, L / R | X97981035130  |               |               |  |
| 23                        | Šroub samořez 3,5x13 DIN 7982 nerez            | 1              | ø3,5x13      | CVSK1-85, 100, L / R | X97982035130  |               |               |  |
| 24                        | Šroub samořez 3,5 x 32 DIN 7981 A2 nerez       | 2              | ø3,5x32      | CVSK1-85, 100, L / R | X97981035320  |               |               |  |
| 26                        | Hmoždinka Ø 8                                  | 3              | ø8x40        | CVSK1-85, 100, L / R | X20600080000  | X20600080000  | X20600080000  |  |
| 27                        | Vrut do hmoždinky 4x40                         | 3              | ø4x40        | CVSK1-85, 100, L / R | X94000040400  | X94000040400  | X94000040400  |  |

|    | Název:                     | Množství [ks]: | Rozměr [mm]: | Pro výrobek: | SIČ bílá:    | SIČ elox:    | SIČ bright:  | Obrázek:  |
|----|----------------------------|----------------|--------------|--------------|--------------|--------------|--------------|---|
| 30 | Dveře CVSK1 ROSA 140/150 L | 1              |              | CVSK1-85L    | XNDCRDV1787L | XNDCRDVX787L | XNDCRDVU787L |  |
| 30 | Dveře CVSK1 ROSA 140/150 R | 1              |              | CVSK1-85R    | XNDCRDV1787R | XNDCRDVX787R | XNDCRDVU787R |  |
| 30 | Dveře CVSK1 ROSA 160/170 L | 1              |              | CVSK1-100L   | XNDCRDV1937L | XNDCRDVX937L | XNDCRDVU937L |  |
| 30 | Dveře CVSK1 ROSA 160/170 R | 1              |              | CVSK1-100R   | XNDCRDV1937R | XNDCRDVX937R | XNDCRDVU937R |  |



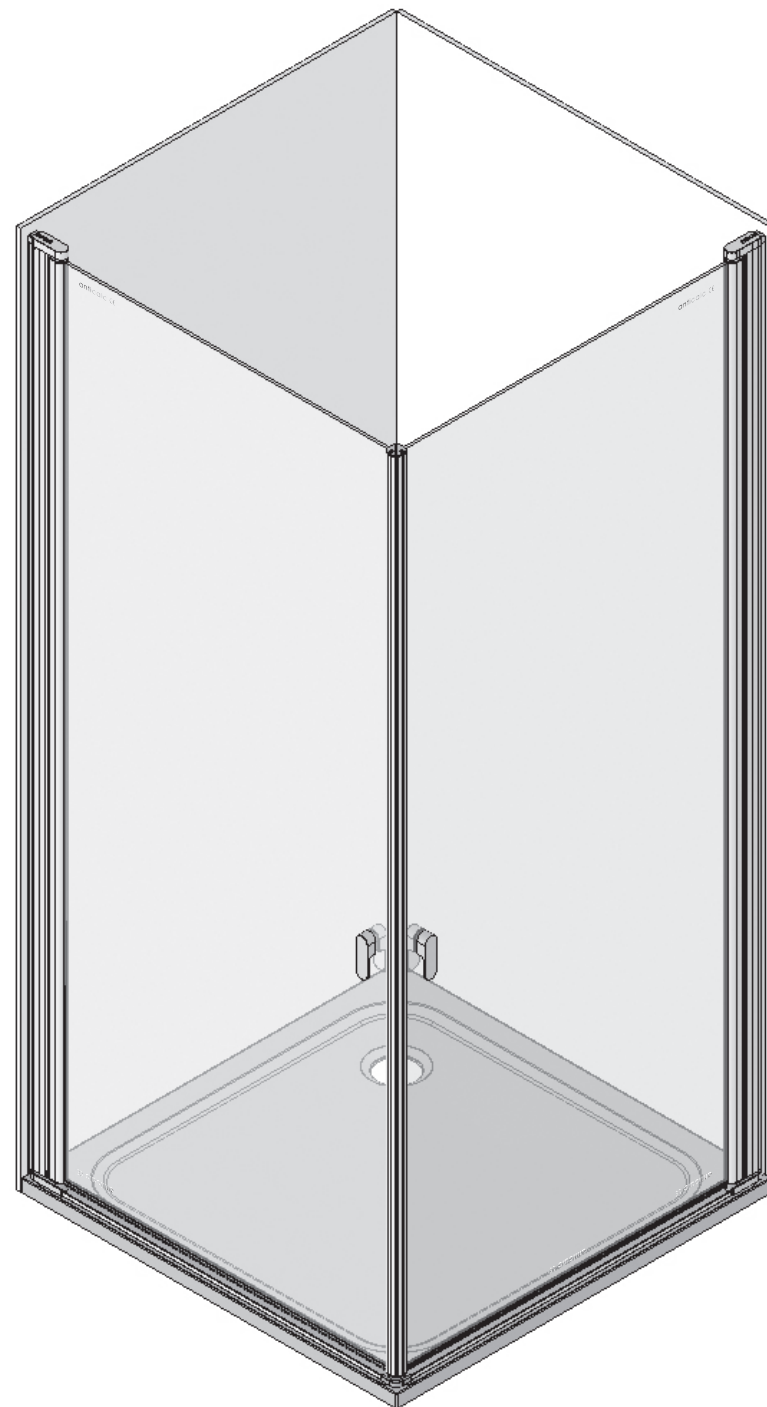

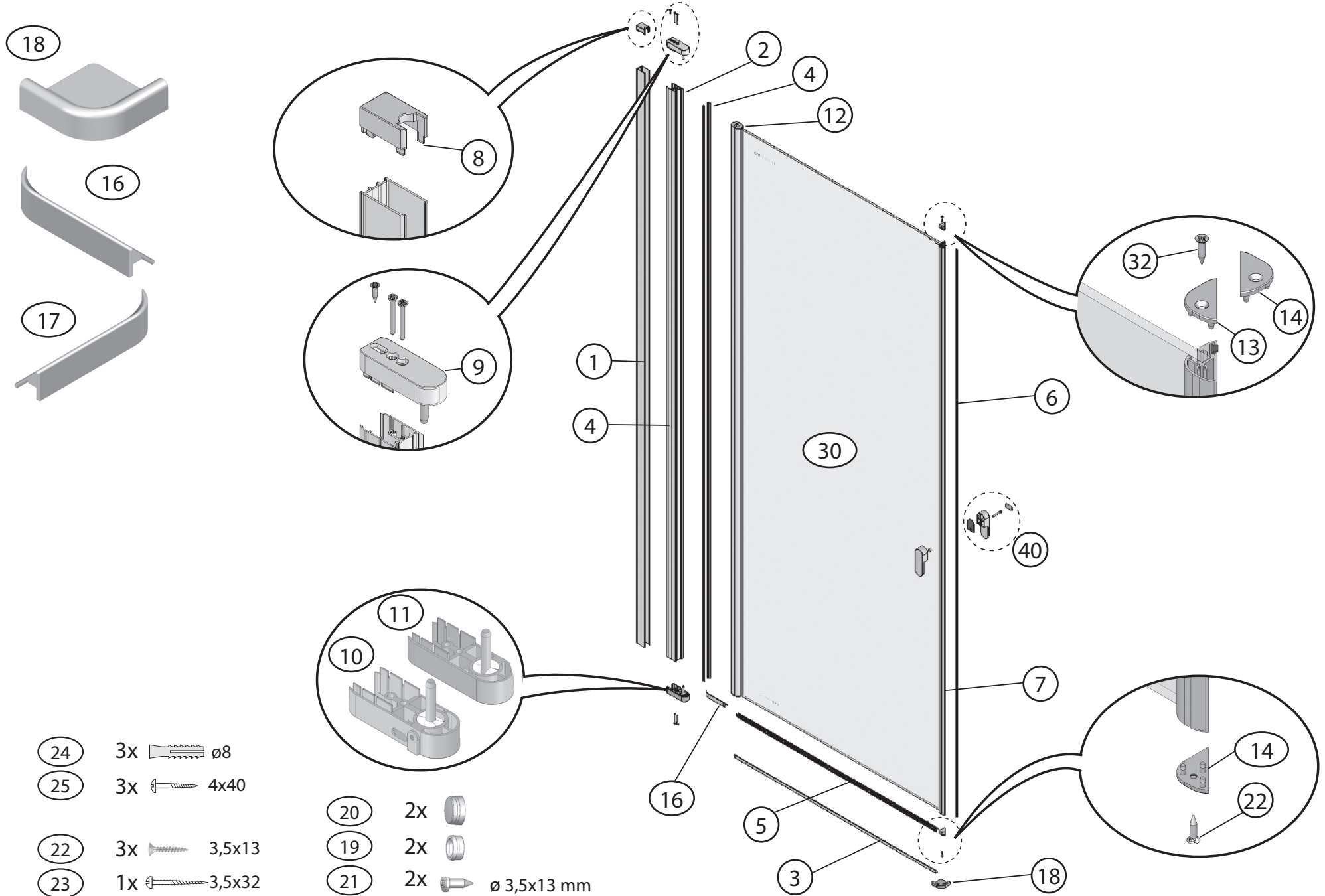



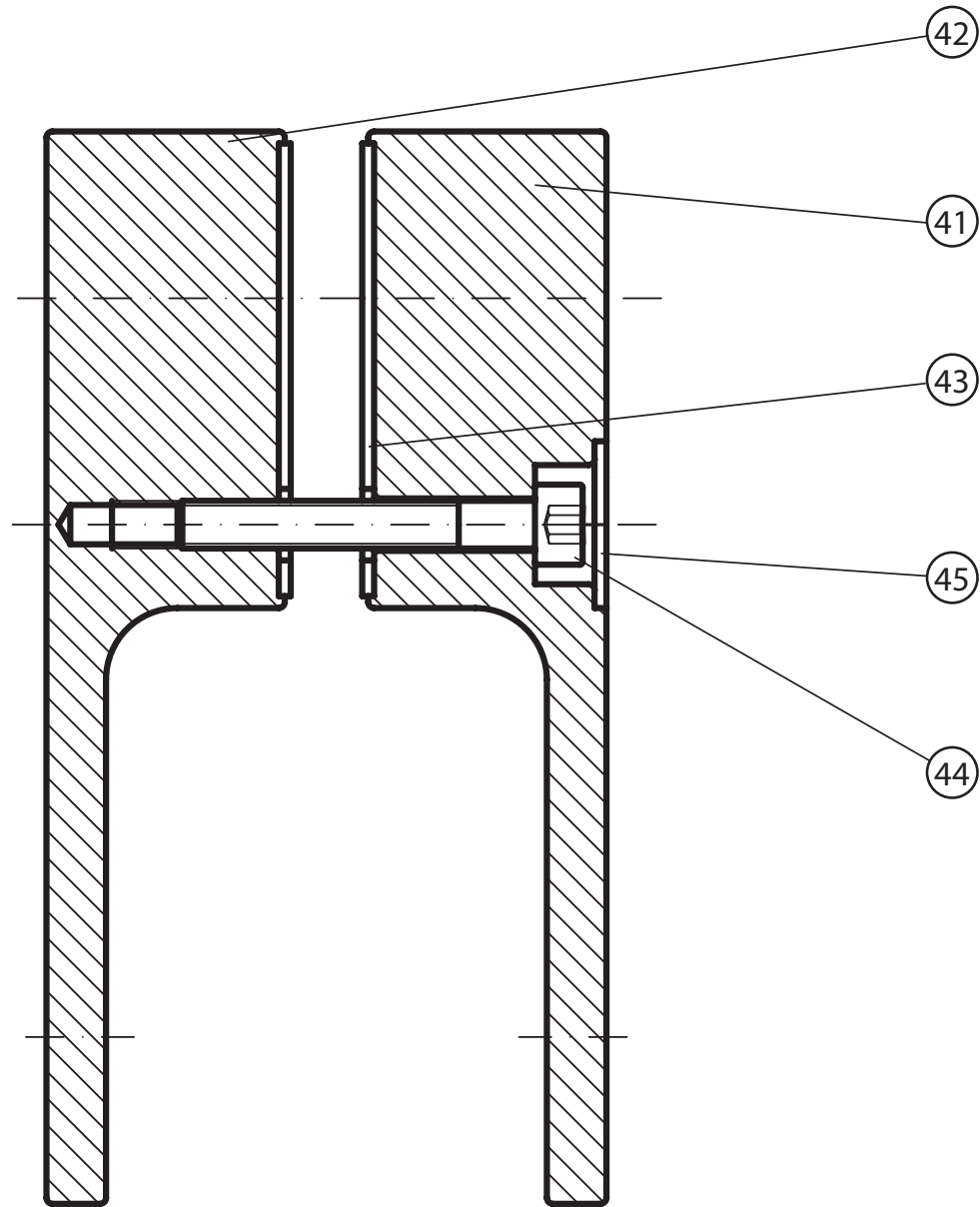











# CRV1 + CRV1 80, 90, 100





















40



| <b>CRV1 80, 90, 100</b> |  |                |              |                |               |               |               |   |
|-------------------------|--|----------------|--------------|----------------|---------------|---------------|---------------|---|
|                         | Název:   | Množství [ks]: | Rozměr [mm]: | Pro výrobek:   | SIČ bílá:     | SIČ elox:     | SIČ bright:   | Obrázek:  |
| 1                       | Ustavovací profil zesílený LR14698               | 1              | 1934         | CRV1-80/90/100 | XVE6980111934 | XVE69801X1934 | XVE69801U1934 |    |
| 2                       | Svislý profil dveře Chrome LR12246               | 1              | 1918         | CRV1-80/90/100 | XVC2460111918 | XVC24601X1918 | XVC24601U1918 |    |
| 3                       | Prahová lišta Chrome rovná Bright 692            | 1              | 692          | CRV1-80        | XVC40812U0692 |               |               |    |
| 3                       | Prahová lišta Chrome rovná Bright 792            | 1              | 792          | CRV1-90        | XVC40813U0792 |               |               |    |
| 3                       | Prahová lišta Chrome rovná Bright 892            | 1              | 892          | CRV1-100       | XVC40814U0892 |               |               |    |
| 4                       | Svislý těsnící profil CHROME dl.1938 mm          | 2              | 1938         | CRV1-80/90/100 | X8CRPL0301938 |               |               |    |
| 5                       | Vodorovná ostřížková lišta CHROME dl.669mm       | 1              | 669          | CRV1-80        | X8CRPL0310669 |               |               |    |
| 5                       | Vodorovná ostřížková lišta CHROME dl.769mm       | 1              | 769          | CRV1-90        | X8CRPL0310769 |               |               |    |
| 5                       | Vodorovná ostřížková lišta CHROME dl.869mm       | 1              | 869          | CRV1-100       | X8CRPL0310869 |               |               |    |
| 6                       | Magnet ILPEA C0921 dl.1909 mm                    | 1              | 1909         | CRV1-80/90     | X6C092101909  |               |               |    |
| 7                       | Svislý magnetový profil 45 Chrome LR12245/1 1909 | 1              | 1909         | CRV1-80/90/100 | XVF4260111909 | XVF42601X1909 | XVF42601U1909 |    |
| 8                       | Krycí plast ust. profilu CR-PL-001               | 1              |              | CRV1-80/90/100 | X8CRPL001000A |               |               |   |
| 9                       | Hlavní díl horní Chrome 2D CR-PL-016-010         | 1              |              | CRV1-80/90/100 | X8CRZA016010A |               |               |  |
| 10                      | Hlavní plast spodní 2D levý CR-PL-006-02L        | 1              |              | CRV1-80/90/100 | X8CRPL00602LA |               |               |  |
| 11                      | Hlavní plast spodní 2D pravý CR-PL-006-02P       | 1              |              | CRV1-80/90/100 | X8CRPL00602PA |               |               |  |
| 12                      | Krycí plast profilu CR-PL-007 / čep              | 2              |              | CRV1-80/90/100 | X8CRPL0070001 |               |               |  |
| 13                      | Krycí plast profilu horní levý CR-PL-009-01L     | 1              |              | CRV1-80/90/100 | X8CRPL00901LA |               |               |  |
| 14                      | Krycí plast profilu horní pravý CR-PL-009-01P    | 1              |              | CRV1-80/90/100 | X8CRPL00901PA |               |               |  |
| 15                      | Zdvihací vložka stavitelná CR-PL-013             | 1              |              | CRV1-80/90/100 | X8CRPL0130001 |               |               |  |
| 16                      | Koncovka prahové lišty D2 levá CR-PL-053-01L     | 1              |              | CRV1-80/90/100 | X8CRPL05301LA |               |               |  |



|    |   |   |          |                |               |              |              |   |
|----|---|---|----------|----------------|---------------|--------------|--------------|---|
| 17 | Koncovka prahové lišty D2 pravá CR-PL-053-01P | 1 |          | CRV1-80/90/100 | X8CRPL05301PA |              |              |    |
| 18 | Rohová spojka prahové lišty CR-PL-051         | 1 |          | CRV1-80/90/100 | X8CRPL051000A |              |              |    |
| 19 | Podložka krytky - Transparent                 | 2 |          | CRV1-80/90/100 | X8A600000000  | X8A600000000 | X8BLPL157000 |    |
| 20 | Krytka šroubu                                 | 2 |          | CRV1-80/90/100 | X8A500000001  | X8A500000000 | X8BLPL15600A |    |
| 21 | Šroub samořezný 3,5x13 DIN 7981 A2 nerez      | 2 | ø3,5x13  | CRV1-80/90/100 | X97981035130  |              |              |    |
| 22 | Šroub samořez 3,5x13 DIN 7982 nerez           | 3 | ø3,5x13  | CRV1-80/90/100 | X97982035130  |              |              |    |
| 23 | Šroub samořez 3,5 x 32 DIN 7981 A2 nerez      | 4 | ø3,5x32  | CRV1-80/90/100 | X97981035320  |              |              |    |
| 24 | Hmoždinka Ø 8                                 | 3 | ø8x40    | CRV1-80/90/100 | X20600080000  | X20600080000 | X20600080000 |    |
| 25 | Vrut do hmoždinky 4x40                        | 3 | ø4x40    | CRV1-80/90/100 | X94000040400  | X94000040400 | X94000040400 |    |
| 30 | Dveře - CRV1 80                               | 1 |          | CRV1-80        | X             | X            | X            |    |
| 30 | Dveře - CRV1 90                               | 1 |          | CRV1-90        | X             | X            | X            |    |
| 30 | Dveře - CRV1 100                              | 1 |          | CRV1-100       | X             | X            | X            |    |
| 40 | Madlo Chrome 3 komplet vč. Obalu              | 2 | set      | CRV1-80/90/100 | X3CRMAD3000A  | X3CRMAD3000A | X3CRMAD3000A |   |
| 41 | Madlo CHROME 1 vnitřní                        | 1 | 90x20x28 |                | ↑set↑         | ↑set↑        | ↑set↑        |  |
| 42 | Madlo CHROME 1 vnější                         | 1 | 90x20x28 |                | ↑set↑         | ↑set↑        | ↑set↑        |  |
| 43 | Podložka madla CHROME 1                       | 2 |          |                | ↑set↑         | ↑set↑        | ↑set↑        |  |
| 44 | Šroub M4x30 DIN 912 A2 nerez                  | 1 | M4x30    |                | ↑set↑         | ↑set↑        | ↑set↑        |  |
| 45 | Krytka nerez pro madlo CHROME 1               | 4 | 24x14    |                | ↑set↑         | ↑set↑        | ↑set↑        |  |

**RAVAK a.s.**, Obecnická 285, 261 01 Příbram I, ČR  
tel.: +420 318 427 111, fax: +420 318 427 278, e-mail: info@ravak.cz, web: www.ravak.cz

**RAVAK SLOVAKIA spol. s r.o.**, Einsteinová 11, 851 01 Bratislava  
tel.: +421 2 / 444 550 01, fax: +421 2 / 444 550 02, e-mail: obchod@ravak.sk, web: www.ravak.sk

**RAVAK POLSKA S.A.**, Kałęczyn, ul. Radziejowicka 124, 05-825 Grodzisk Mazowiecki, POLSKA  
tel.: 22 / 755 40 30, fax: 22 / 755 43 90, e-mail: info@ravak.pl, web: www.ravak.pl

**RAVAK Hungary Kft.**, 1142 Budapest, Erzsébet királyné útja 125, HUNGARY  
tel.: 06 (1) 223 13 15, 06 (1) 223 13 16, fax: 06 (1) 223 13 14, e-mail: info@ravak.hu, web: www.ravak.hu

**Ravak Gesellschaft für Sanitärprodukte mbH**, Alexanderstrasse 58, D - 45472 Mülheim an der Ruhr  
tel. (0208) 37789-30, fax. (0208) 37789-55, e-mail: info@ravak.de, web: www.ravak.de

**RAVAK a.s.**, Representative Office in Ukraine, 21 Dniprovská Naberezhna str., 2nd floor, 02081, Kyiv, Ukraine  
tel.: 00380 44 2203232, 00380 44 3605200, fax: 00380 44 2204343, e-mail: ravak@ravak.kiev.ua, web: www.ravak.ua

**OOO RAVAK ru**, ul. Staropetrovskiy pr. 7A, Moskva 125 130,  
tel./fax: 007 495 710 82 23, 007 495 450 12 77, e-mail: ravak@inbox.ru, web: www.ravak.com

**RAVAK Baltic**, Butrimonių g. 5, Kaunas, Lietuva,  
tel.: +370 37 328013, faks: +370 37 328016 El. paštas: info@ravak.lt

# RAVAK®

**RAVAK a.s.**, Obecnická 285, 261 01 Příbram I  
tel.: +420 318 427 200, 318 427 111 fax: +420 318 427 269  
e-mail: info@ravak.cz, **www.ravak.com**

Výrobce si vyhrazuje právo změny ceny, technických parametrů, či dalších skutečností  
bez předchozího upozornění a nenese odpovědnost za tiskové chyby.